



2.5M COMPOSITE SLATTED CLADDING DOUBLE END TRIM

Complete your Slatted Wall Cladding project with Cladco Composite Double End Profile Trims, designed to fit seamlessly into the final Panel for a professional and polished finish.

Each 2.5m Trim features a textured grain effect, providing a durable, low-maintenance edging solution that enhances the overall appearance of your installation.

COLOUR RANGE

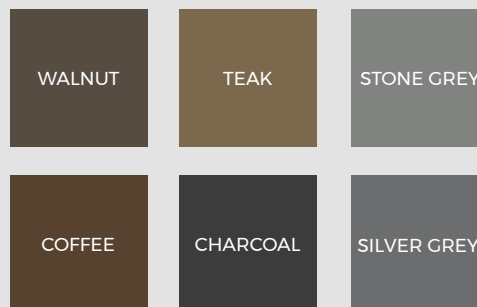

PANEL SPECIFICATIONS

Length	2.5m
Width (inc. Lip)	105mm
Thickness	26mm
Finish	Textured Grain
Weight	3kg



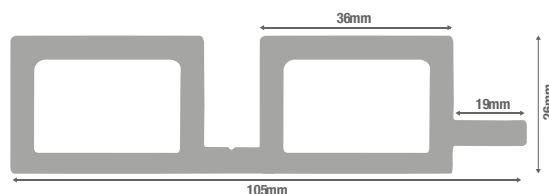

TEST CERTIFICATIONS

FSC® Certification

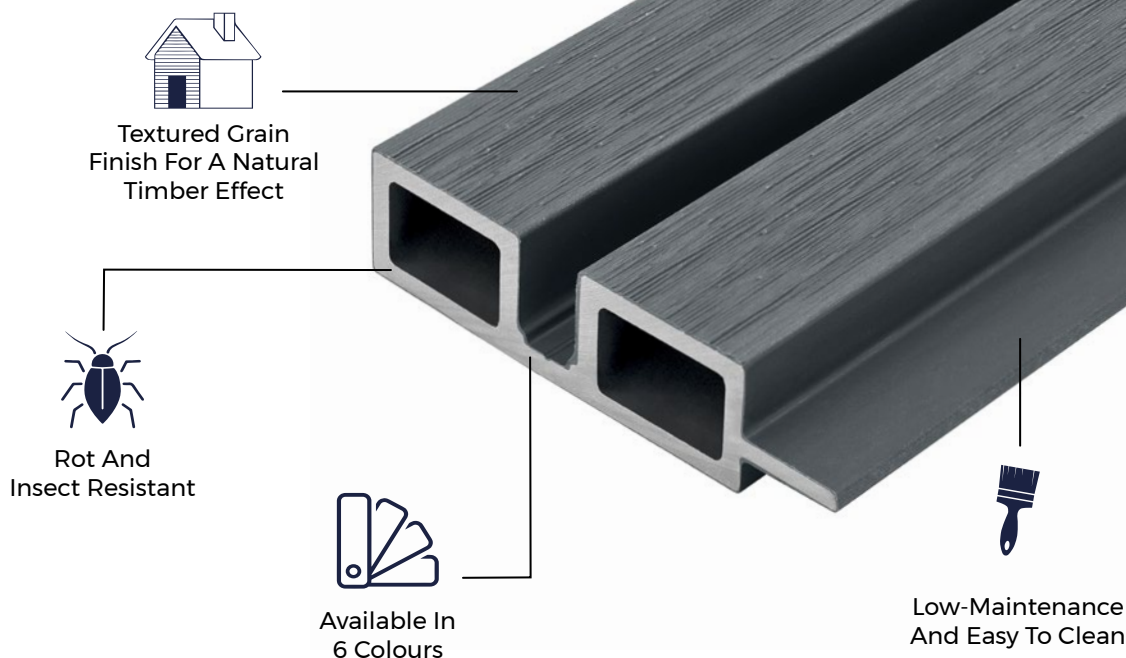
SA-COC-005542





 <p>MATERIALS</p> <p>Capped Composite Wood-Plastic Blend - Made from 60% hardwood fibres and 40% recycled plastics for enhanced durability and sustainability.</p>	 <p>SURFACES</p> <p>Textured Grain Effect - Achieves the look of natural timber without the ongoing maintenance required for traditional wood cladding.</p>	 <p>ACCESSORIES</p> <p>Available accessories include Composite Slatted Wall Cladding Panels, Internal Corner Profile Trim, External Corner Trim, Start Profile Trim, and Double End Profile Trims for a complete and seamless installation.</p>	 <p>LOW MAINTENANCE</p> <p>Corner Trims feature a low-maintenance, rot-resistant construction, making them durable and easy to work with for a seamless Cladding installation.</p>	 <p>INSTALLATION</p> <p>Corner Trims are installed under the Battens at the base or top of the installation, effectively concealing exposed corners or edges for a neat and professional finish.</p>
--	---	---	--	--

GENERAL CLEANING

For everyday debris such as leaves, berries, plants, and animal droppings, simply clear the surface with a brush. Regular maintenance is recommended to keep your Cladding clean and in the best condition.

To clean, mix a light detergent with lukewarm water and use a soft cloth or brush to gently remove dirt and buildup from the Cladding Panels.

NATURAL WEATHERING

Cladco External Wall Cladding is designed with an encapsulated, non-porous outer layer, providing protection against weathering, water, and UV damage. Over time, some natural weathering may occur, depending on location and sunlight exposure. This process is normal and part of the material's natural character, ensuring long-term durability and performance. This is a normal process and part of the natural character of the material.

RECYCLED MATERIALS & SUSTAINABILITY

Cladco Capped Composite Trims are manufactured using recycled materials, helping to reduce environmental impact. Each Trim is made from 60% recycled hardwood fibres and 40% post-consumer recycled plastics, offering low-maintenance and long-lasting benefits.

To enhance durability, additional bonding agents are used to create a strong composite core, which is then capped with a hard-wearing outer layer for superior protection.

All Cladco Composite products are available as FSC® certified at no additional cost. If you require FSC® certified products, please request this when placing your order.

DOUBLE END PROFILE TRIM INSTALLATION ADVICE

Double End Profile Trims should be installed along the side edges of your Slatted Wall Cladding to create a seamless and professional finish.

When installing a Slatted Cladding Panel next to a Double End Profile Trim, ensure a 5mm expansion gap between the Panel and the Trim face to allow for natural movement.

Secure the Trim to the supporting Battens underneath by fixing through the channel between the two slats for a strong and stable installation.

For detailed installation guidance, please refer to our Installation Guide.

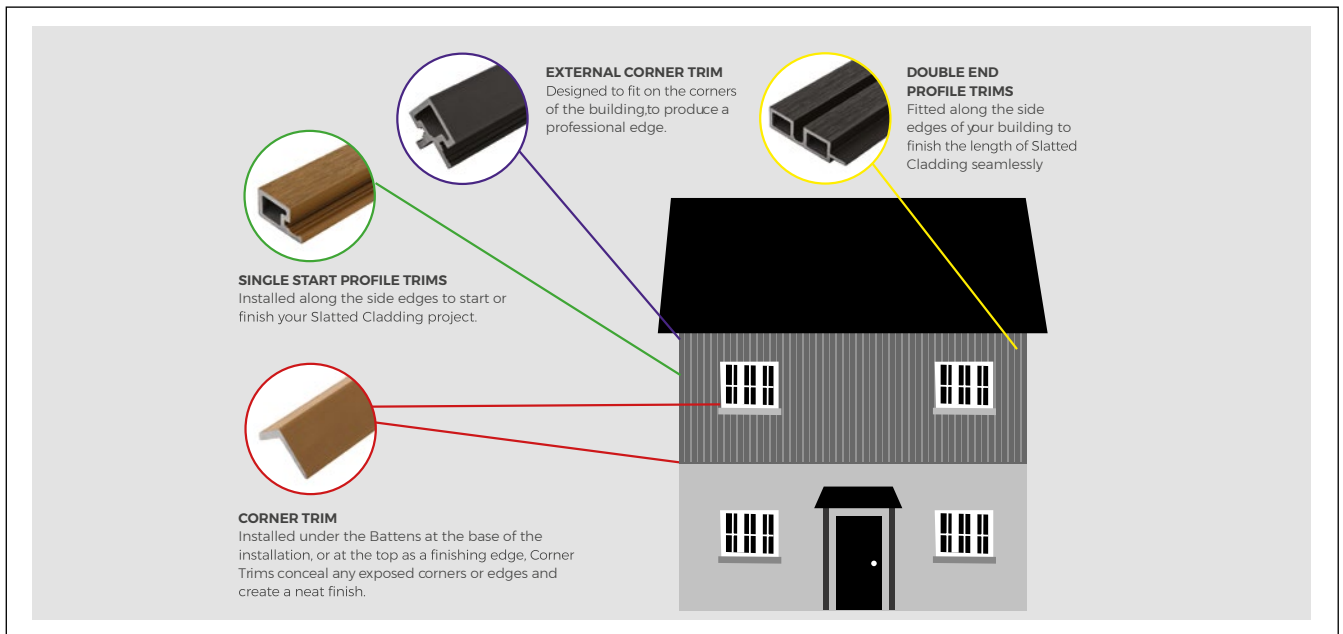
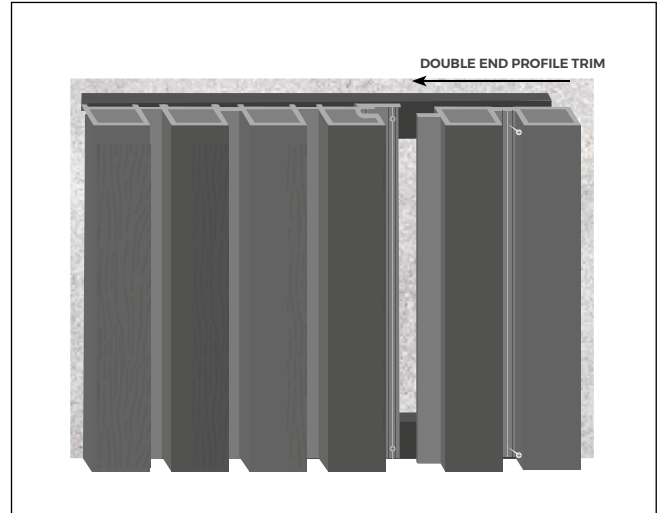

Adhering to these guidelines will ensure the proper installation and longevity of your Slatted Cladding Project. Failure to follow these guidelines may void the product warranty.

For full installation details, please refer to our External Slatted Cladding Installation Guide.

PRODUCT ACCESSORIES

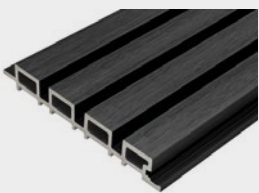

2.5M EXTERNAL
SLATTED CLADDING



EXTERNAL
CORNER TRIM

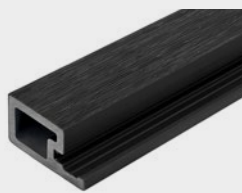

SINGLE
START TRIM

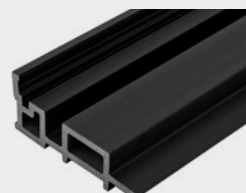

INTERNAL
CORNER TRIM

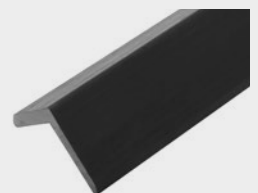

CORNER TRIM