

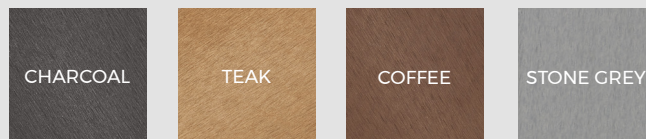

# 3M POST COMPOSITE FENCING

Cladco Composite Fence Posts are available in 3m lengths and are designed to be installed with Cladco Composite Fencing Panels. Posts are made from 100% recycled materials, with marked channels on four sides for easily slotting Panels into for a secure Fencing project.

## COLOUR RANGE



## POST SPECIFICATIONS



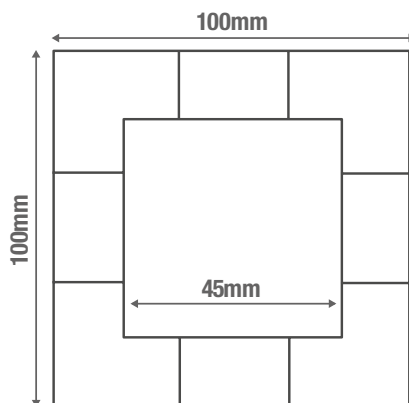

Length	3m
Width	100mm x 100mm
Height	16.5kg

## TEST CERTIFICATIONS

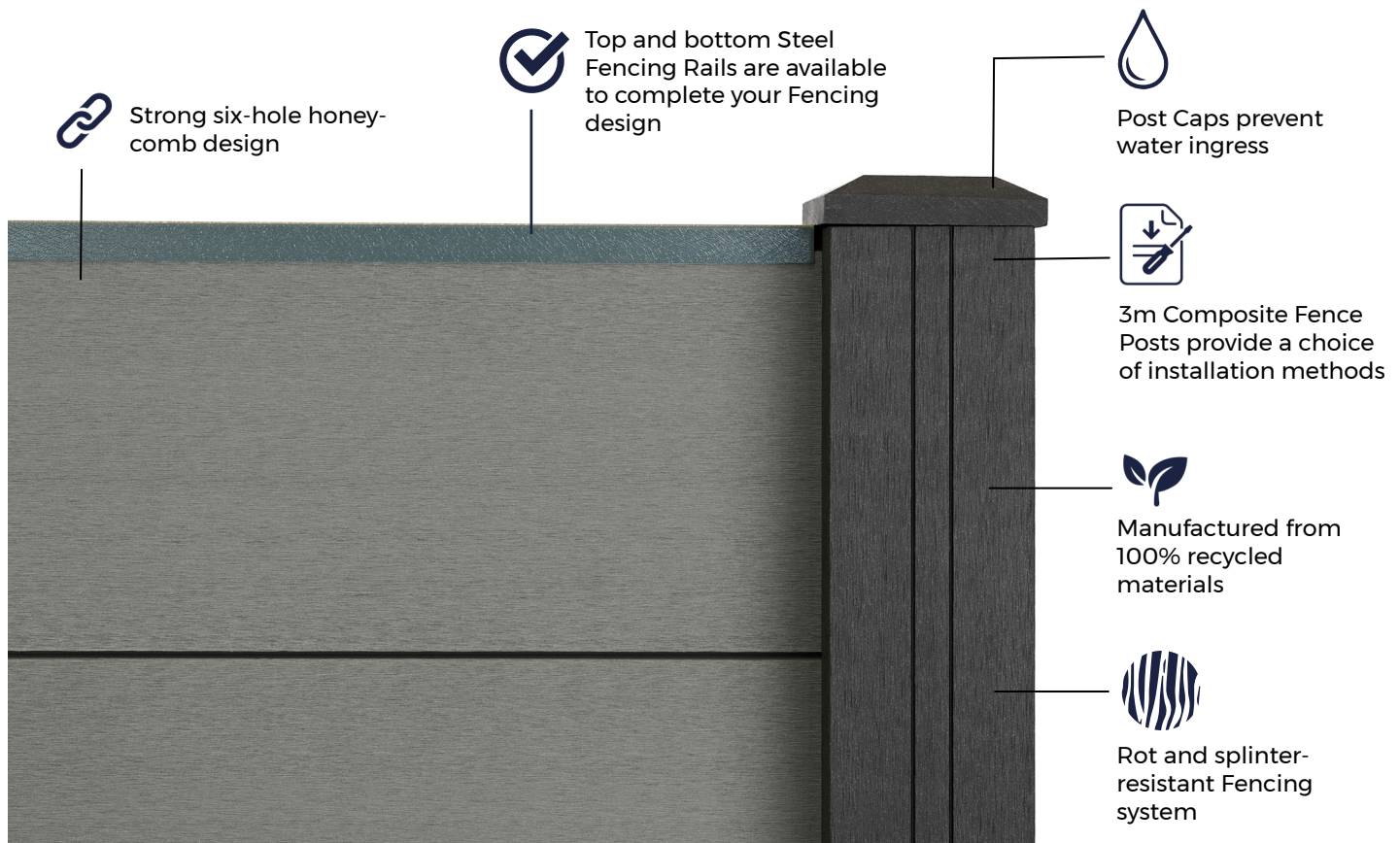
FSC® Certification SA-COC-005542





 <p><b>MATERIALS</b></p> <p>Composite wood-plastic mix comprising 60% hardwood fibres, 40% recycled plastics.</p>	 <p><b>INSECT RESISTANCE</b></p> <p>The recycled plastic content in Composite Fencing resists insects and pest damage.</p>	 <p><b>ACCESSORIES</b></p> <p>Composite Fencing Panels and Post Caps will be required to complete your project.</p>	 <p><b>LOW MAINTENANCE</b></p> <p>Cladco Composite Fencing Posts do not need staining, varnishing or treating.</p>	 <p><b>LONG LASTING</b></p> <p>Cladco Composite Posts are a long lasting addition to your outdoor project.</p>
--	---	--	---	---

## RECYCLED MATERIALS

Cladco Composite Fencing is composed of 100% recycled materials consisting of 60% recycled hardwood fibres and 40% recycled plastic. As post-consumer plastic is utilised in Composite Fencing, it makes for an environmentally friendly option.

Additives of anti-UV agents, tints and bonding agents are included to bind together the recycled materials, this allows for a sturdy and long-lasting Fence.

All Cladco Composite products are available as FSC® certified for the same cost. If you require FSC® certified products, please ask for these when placing your order.

All Cladco Composite products are available as

FSC® certified for the same cost. If you require FSC® certified products, please ask for these when placing your order.

## AFTERCARE

As a Composite material, Cladco Composite Fencing Posts will naturally accumulate dirt when exposed to outdoor conditions. For everyday debris such as plants, leaves, berries, or animal droppings, simply brush your Fencing with a brush and warm, soapy water.

In cases of more stubborn dirt or grime, pressure washing may be necessary to restore the Fencing's appearance.

## INSTALLATION ADVICE

### Prepare The Area

Remove any debris from the area and mark the Fence Post holes. These should be dug 25% of the Post's height. To efficiently support the Fence Panels, Posts must be a maximum of 1.8m apart.

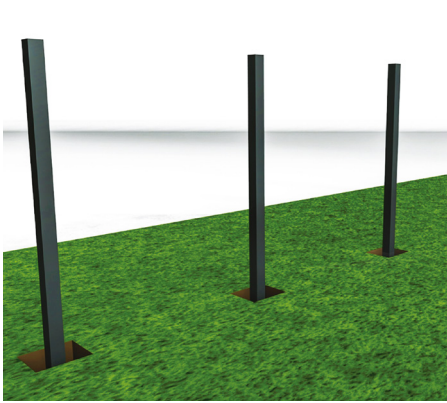

### Method One

The slot between method requires Fence Panels to be cut into lengths of 1.8m. Panels simply slot into the grooves of the Posts once channelled out. Posts can then be topped with Fence Post Caps and Fence Rails to complete the project.

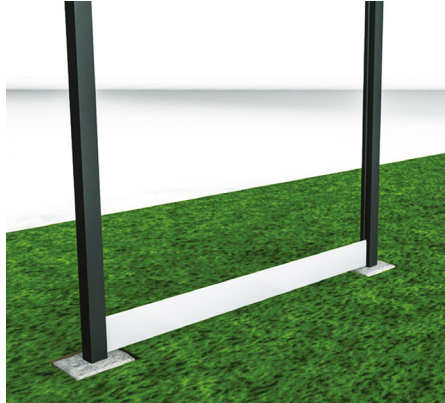

### Method Two

Alternatively, secure each 3.6m Panel to the front of the Posts, with a Composite Post every 1.8m apart for support. The top and bottom of the Fence Panels should then be screwed to the front of the Posts.



## COLOUR STABILISATION

All Cladco Composite products contain UV stabilisers; however, due to their natural elements, all Composite products will undergo an initial colour stabilisation process. This may result in some changes in colour during the first few months after installation as the product acclimatises to its environment.

## NATURAL WEATHERING

As Cladco Composite Fencing Posts contain natural wood elements, they will fade from weathering over time. This process is most noticeable within the first six months after installation.

Please be aware that the appearance of Composite Posts will change depending on weather conditions and, when wet, Posts will display a different tone compared to when they are dry.

For detailed information about installation, please read our Composite Fencing Installation Guide.

## PRODUCT ACCESSORIES

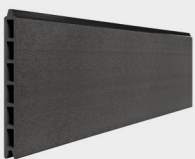

FENCING PANEL

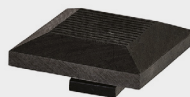

FENCING POST CAPS

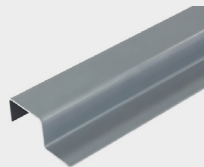

CONCRETE POST SPACER

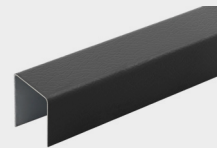

SKIRTING TRIMS



STRAIGHT CUT TIN SNIPS