

Proud To Be The UK's  
Leading Supplier Of  
Composite Decking



SCAN ME

ORDER ONLINE  
[www.cladcodecking.co.uk](http://www.cladcodecking.co.uk)  
or call **01837 659901**

**CLADCO**  
PROFILES



Pictured - Silver Birch Nordeck Woodgrain Effect Decking Boards

## CONTENTS

- 4 Cladco Profiles
- 5 Quality And Service
- 6 Composite Decking Range
- 10 Nordeck Woodgrain Effect Decking Range
- 11 Bamboo Hardwood Decking
- 16 Aluminium Decking Range
- 18 Framework And Decking Accessories
- 22 Balustrade System
- 24 Composite Wall Cladding And Accessories
- 28 Composite Slatted Wall Cladding
- 30 Fibre Cement Wall Cladding And Trims
- 34 Internal Slatted Wall Panels
- 36 Composite Fencing And Accessories
- 38 Installation Guides
- 40 Composite Decking Installation Guide
- 43 Nordeck Decking Installation Guide
- 47 Composite Wall Cladding Installation Guide
- 50 Fibre Cement Wall Cladding Installation Guide
- 56 Case Studies

FREE  
SAMPLE PACK



SCAN ME

# Cladco Profiles

## About Us

Established in 1972, Cladco Profiles is a family-run business based on the edge of Dartmoor in Okehampton, Devon. We supply the UK with high-quality exterior and interior products, including Composite Decking, Composite Wall Cladding, Nordeck Decking, Fibre Cement Cladding and Composite Fencing.

Our commitment to product innovation and customer service has enabled us to become the UK's Leading Supplier of Composite Decking. As a business, we are constantly adapting to our customers' requirements and have

a team of highly trained experts to help with your project, from quoting materials through to installation advice.



SCAN ME



Lawrence Trescher *Company Director*



## Certifications



ISO 9001 is the world's most recognised Quality Management System Standard. ISO 9001 is designed

to ensure organisations meet the needs of customers and other stakeholders, by having a framework in place that helps ensure consistent quality in the provision of goods and services.



ISO 45001 - Occupational Health and Safety Management Performance accredited by ISO. ISO 45001

Standard reduces workplace risks to improve employee safety. This Standard surpasses many existing health and safety standards because it has been developed by a committee of occupational health and safety experts.



ISO 14001 Environmental Management is the International Standard for Environmental

Management Systems (EMS). It was designed by the International Organisation for Standardisation (ISO) to help businesses and other organisations reduce their environmental impact.



All Cladco Composite products are available as FSC® certified for the same cost. If you require FSC® certified products, please ask for these when placing your order.

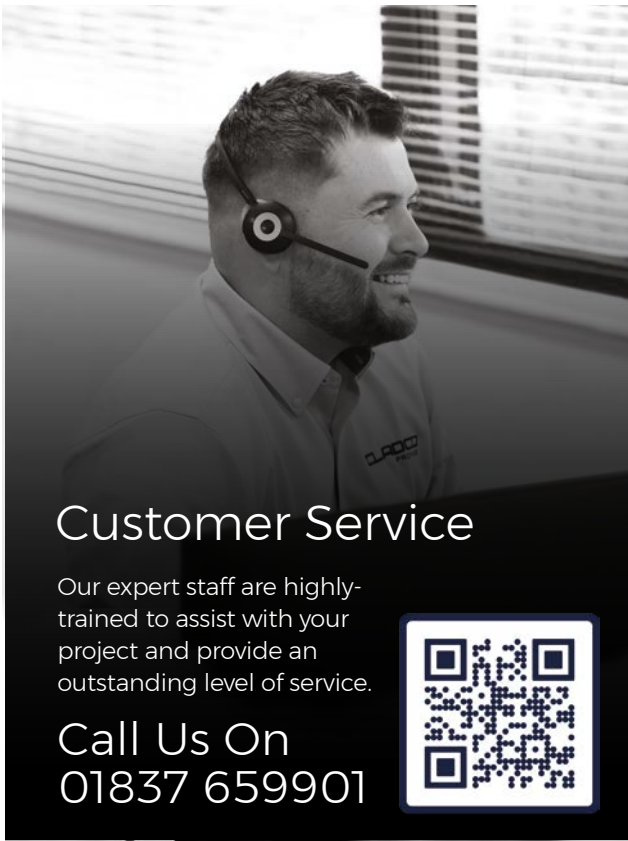

### Customer Service

Our expert staff are highly-trained to assist with your project and provide an outstanding level of service.

Call Us On  
01837 659901



We are constantly reviewing the way we work and setting new targets to ensure that, as a business, we are being as environmentally friendly as we can. In 2023, we helped prevent the equivalent of over 328 million plastic bottles from entering our oceans. All our Composite Boards are manufactured using 40% recycled plastic, protecting our sea life from plastic and giving our Boards a range of beneficial properties.

For more examples of how we are reducing our carbon emissions and working in an environmentally-friendly way, please visit our website.



### Installation Guides

Easy-to-follow Installation Guides can be found on our website for all Decking, Wall Cladding and Fencing products, as well as Installation Videos on YouTube.



### Product Calculators

Decking, Wall Cladding and Fencing Calculators on our website will be able to calculate how many Boards you'll need and provide you with a quote.

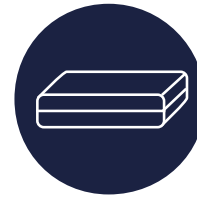

### Sample Packs

Want to see the quality and colours of our products before purchasing? Order Samples from our website with a choice of products available.

## Cladco Roofing Sheets

We are also the UK's Leading Supplier of Steel Roofing Sheets in a variety of colours and coatings, as well as custom-made Flashings and Accessories. Please visit our other website to find out more.

[www.cladco.co.uk](http://www.cladco.co.uk)





# Composite Decking Range

The material used in our Composite Decking is a wood and plastic mix, comprising 60% recycled hardwood fibres and 40% high-grade recycled plastics. This is mixed together and then extruded to form either a Hollow or Solid Decking Board.

The benefit of mixing these two product groups ensures you have a reliable,

high-end product which is durable, hard-wearing, low-maintenance and guaranteed for 15 years.

Installation is easy, as Cladco Composite Decking can be worked with normal woodworking tools and is easily fastened to a suitable supporting joist substructure with our Stainless Steel Screws and T-Clip System.



No need to seal, stain or paint



Splinter, rot and warp resistant



Resistant to attack by insects



Low water absorption rate



Anti-UV agent resists colour fade



Sample Packs available to order



SCAN ME



Decking Calculator

Pictured - Stone Grey Woodgrain Effect Decking Boards with Charcoal Bullnose Boards  
Please note this style of Bullnose Board is now discontinued.

\*We advise installing Composite Decking Boards onto Cladco Recycled Plastic Decking Subframes, and in accordance with our Installation Guide, to qualify for the 15-year guarantee. Please refer to our installation guide.



## Hollow Or Solid Core?

Solid Core Boards offer greater strength and sound absorption, and are often favoured for commercial applications and decks which may be subjected to heavier use. The right choice of Board, however, depends on the circumstances. If in doubt, call our friendly Customer Service Team on **01837 659901**.

Both types of Board are high-quality products manufactured to specific requirements and are warranted to be free from material defects in workmanship and materials.



## Colour Variations

Composite 2.4m and 4m Decking Boards may have slight colour variations between batches. To avoid colour variation between Boards, please order all required Boards at the same time in the same lengths.



SCAN ME

# COMPOSITE DECKING

## GROOVED COMPOSITE DECKING BOARD

Utilising a honeycomb structure that makes the Boards lightweight, Cladco Grooved Decking is made from a combination of 60% recycled hardwood fibres and 40% high-grade recycled plastic, bonding agent, additives and tint. Each Hollow Composite Decking Board is reversible, with one side featuring narrow grooves for low-slip properties and one side featuring a Woodgrain Effect. The narrow-groove side provides the Board with low-slip properties, as well as making it less susceptible to watermarks and staining.



### MEASUREMENTS

Lengths: 2.4m & 4m  
Width: 150mm  
Thickness: 25mm  
Weight (2.4m): 6.72kg  
Weight (4m): 11.2kg  
Colour: 8 Colours

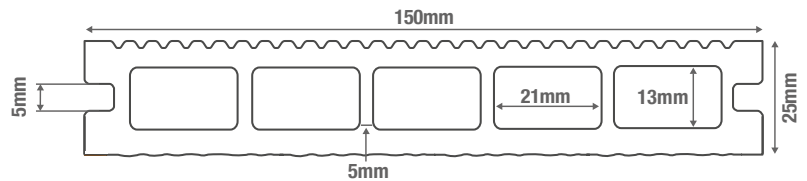

## WOODGRAIN COMPOSITE DECKING BOARD

Cladco Woodgrain Effect Composite Decking Boards have been designed to replicate the look of natural timber. They are available in eight colours and feature a reversible design. Our Composite Boards provide you with the choice of either a detailed Woodgrain Effect or narrow grooves for low-slip benefits. Woodgrain Effect Composite Decking is manufactured in the same way as all our Composite Decking Boards, combining 60% recycled hardwood fibres\* and 40% recycled plastics, bonding agents, and tints.



SCAN ME

### MEASUREMENTS

Lengths: 2.4m & 4m  
Width: 150mm  
Thickness: 25mm  
Weight (2.4m): 12.55kg  
Weight (4m): 20.92kg  
Colour: 8 Colours

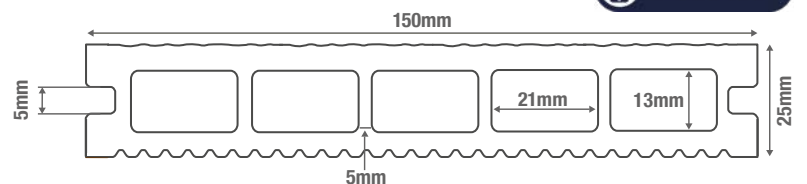

\*We advise installing Composite Decking Boards onto Cladco Recycled Plastic Decking Subframes, and in accordance with our Installation Guide, to qualify for the 15-year guarantee. Please refer to our installation guide.



Composite Decking Sample Packs available



## SOLID COMPOSITE DECKING BOARD

Solid Composite Decking offers an authentic woodgrain finish on one side and a low-slip grooved finish on the other. Solid decking provides extra reliability underfoot, making the boards best suited for commercial settings. Cladco Reversible Solid Composite Decking Boards have improved sound-dampening properties for areas that will be subjected to larger loads, heavier objects, or higher footfall.

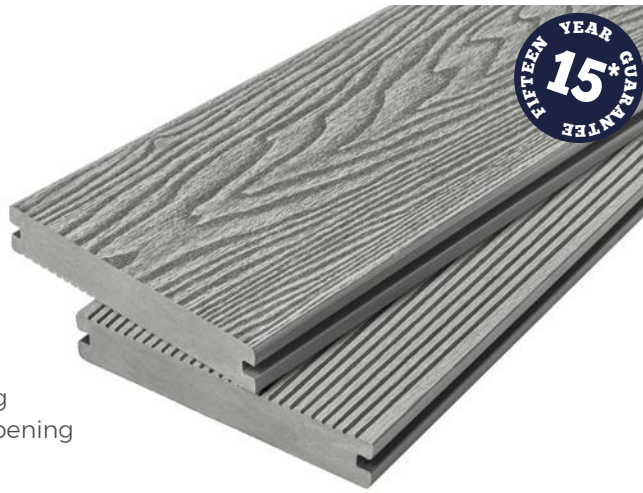

### MEASUREMENTS

Lengths: 4m  
 Width: 150mm  
 Thickness: 25mm  
 Weight: 20.92kg  
 Colour: 8 Colours

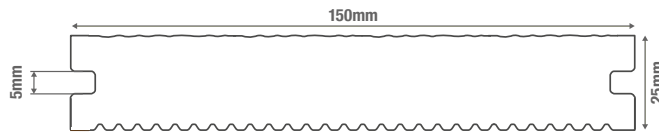

## AVAILABLE COLOURS

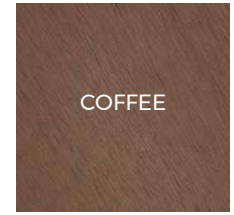

## SOLID COMPOSITE BULLNOSE BOARD

For a neat and sophisticated finish to your Composite Decking, choose our Reversible Bullnose Composite Decking Boards. Featuring a curved edge, with the option to install a woodgrain effect or narrow grooved surface, Bullnose Decking can complement or contrast your Decking area for a unique, contemporary design.



### MEASUREMENTS

Length: 4m  
 Width: 150mm  
 Thickness: 25mm  
 Weight: 20.52kg  
 Colour: 8 Colours

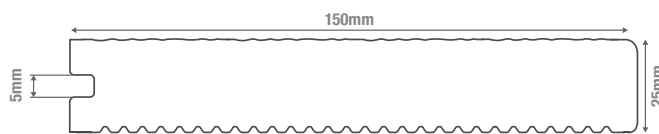

# Nordeck Woodgrain Effect Decking Range

Cladco Nordeck Woodgrain Effect Decking has a dense PVC core encased in ASA (acrylic-styrene-acrylonitrile), which is the most weather-resistant resin currently available on the market providing superior strength. Nordeck Decking is wood-free yet still gives a premium wood effect without the concerns of fading, staining or scratching. Nordeck Decking can be

installed low to the ground and in very damp areas due to its moisture-resistant properties. Thanks to these benefits, our Nordeck Decking Boards are perfect for installation around pools, under hot tubs or in other areas with a high amount of moisture. Nordeck Decking can also withstand both standing water, damp and harsh weather conditions.



Stain resistant



Mould resistant



Superior UV protection



Scratch resistant



Resists against moisture damage



Suitable for harsh climates



Samples available to order



SCAN ME



Decking Calculator

Pictured - Cedar Wood Nordeck Woodgrain Effect Decking Boards



CLADCO

DECKING

EXTERNAL CLADDING

INTERNAL PANELLING

FENCING

INSTALLATION GUIDES

CASE STUDIES

# NORDECK WOODGRAIN EFFECT DECKING

## NORDECK DECKING BOARD

Cladco Nordeck Woodgrain Effect Decking Boards offer an authentic woodgrain surface without the ongoing maintenance associated with natural timber. Nordeck Decking is resistant to moisture, staining and scratching. Cladco Nordeck Decking is the superior, premium synthetic Decking material of choice. Unlike most traditional Decking solutions, our Nordeck Decking provides a luxury embossed finish, colour and texture. Nordeck Decking is available in seven colours to suit your project.



### MEASUREMENTS

Length: 3.6m  
Width: 200mm  
Thickness: 32mm  
Weight: 18.20kg  
Colour: 7 Colours

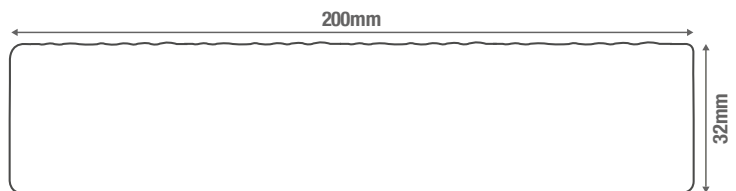

## NORDECK BULLNOSE BOARD

Cladco Nordeck Woodgrain Effect Bullnose Boards have a superior woodgrain finish and feature a rounded edge on one side to complete your Decking project. Nordeck Bullnose Boards are timber-free which reduces the possibility of fading, scratching or staining, whilst still featuring a natural timber-like effect without compromising on quality. The dense core within our Boards is made from PVC, which is coated in ASA (acrylic-styrene-acrylonitrile), the highest quality, weather-resistant resin available.



### MEASUREMENTS

Length: 3.6m  
Width: 150mm  
Thickness: 32mm  
Weight: 11.16kg  
Colour: 7 Colours

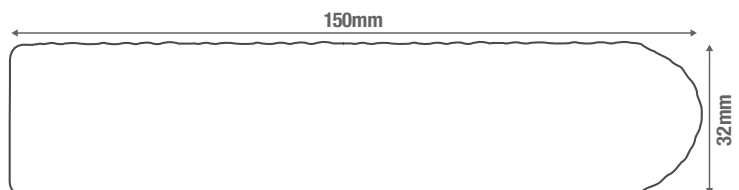

## NORDECK FASCIA BOARD

Cladco Nordeck Woodgrain Effect Fascia Boards are made from the same high-quality synthetic material as Nordeck Decking and are the perfect choice for those wanting a superior product. Fascia Boards can be used to conceal the underneath of a Decking frame as a professional way to finish an installation. Our Nordeck Woodgrain Effect Range, unlike most Decking solutions on the market, offers a luxury woodgrain finish, colour and texture, and is available in a wide choice of seven attractive colours.



### MEASUREMENTS

Length: 3.6m  
 Width: 140mm  
 Thickness: 15mm  
 Weight: 4.95kg  
 Colour: 7 Colours

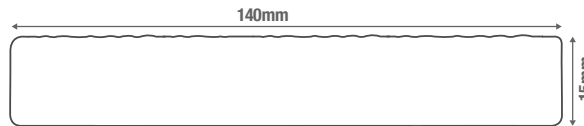

## NORDECK DECKING ACCESSORIES

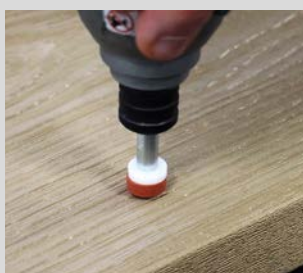

### HIDDEN DECK FASTENERS

Achieve a discreet finish by hiding Screws on the surface of Nordeck Decking Boards.  
**Pack Quantity:** 100  
 Supplied with 65mm Screws and 7mm Colour Plugs.

## AVAILABLE COLOURS



### DECKING SAMPLES AVAILABLE

Samples are available from our website.

# Bamboo Hardwood Decking

Cladco Bamboo Hardwood Decking is a highly durable and robust material featuring a solid core that provides increased strength across the Board. Due to these factors, Bamboo Decking Boards can be installed in a range of domestic and commercial settings.

Made from bamboo, a renewable and fast growing

plant, Bamboo Decking is a sustainable choice of material that provides a natural appearance for your project.

Our Bamboo Decking Boards benefit from having resistance to rot, mildew and corrosion, providing a long lifespan. A simple Fixing Clip system makes Bamboo Decking easy to install and versatile for all projects.



Superior strength and durability



Mould and mildew resistant



Made with sustainable materials



Scratch resistant



Samples available to order



 SCAN ME

Pictured - Natural Oiled Bamboo Hardwood Decking Boards

## BAMBOO HARDWOOD DECKING BOARD

Cladco Bamboo Hardwood Decking Boards feature a reversible design that consists of one grooved side, which provides low-slip\* benefits, and one smooth side. Each Board is pre-coated with a layer of exterior-grade oil. Once installed, applying an additional layer of exterior decking oil, and reapplying twice a year—once in spring and once in autumn—will keep the Boards looking their best and help preserve colour. If left untreated, Bamboo Decking Boards will naturally weather to a soft grey.

### MEASUREMENTS

Length: 2.4m & 3m  
 Width: 140mm  
 Thickness: 20mm  
 Weight: 7.66kg (2.4m)  
 9.58kg (3m)  
 Colour: Natural Oiled

\*In dry conditions only.

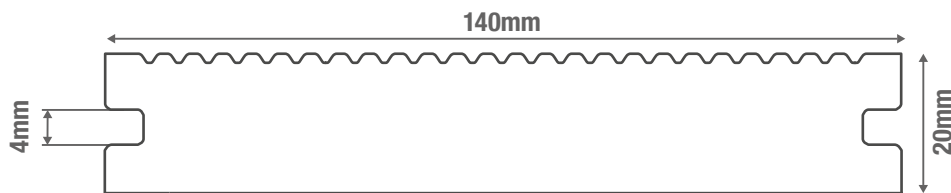

### BAMBOO DECKING SAMPLE PACK

Samples of our Bamboo Hardwood Decking are available to order.

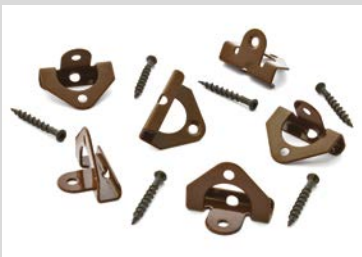

### BAMBOO DECKING STARTER CLIPS

Starter Clips for Bamboo Decking will ensure Boards are installed evenly next to walls or fence lines.

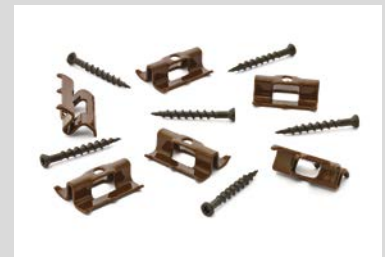

### BAMBOO DECKING FIXING CLIPS + SCREWS

Bamboo Decking Boards are installed with a simple Fixing Clip system.

# Aluminium Decking Range



Cladco Aluminium Decking is a high-quality, non-combustible Decking solution that has been engineered to be fully compliant with the latest fire safety regulations. This makes for an ideal product for installations within mid to high-rise buildings.

Measuring 3.6m in length, Aluminium Decking Boards are lightweight and long-lasting. Available in four colours with a powder-coated finish, plus a plain anodised Aluminium option, you can create the perfect look for balconies, rooftops, walkways and more.



Easy to clean



Non-combustible fire rating (A2-S1)



Rot and insect resistant



Lightweight and strong



SCAN ME

Pictured - Plain anodised Aluminium Decking Boards



# ALUMINIUM DECKING

## ALUMINIUM DECKING BOARD

Aluminium Decking Boards are lightweight, durable and non-combustible, available in four powder-coated colours, as well as plain anodised Aluminium.

### MEASUREMENTS

Length: 3.6m  
Height: 150mm  
Thickness: 25mm  
Weight: 7.98kg  
Colour: 5 Colours

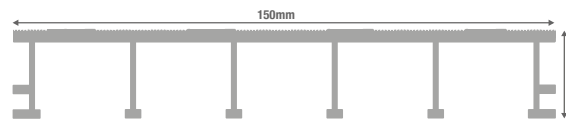
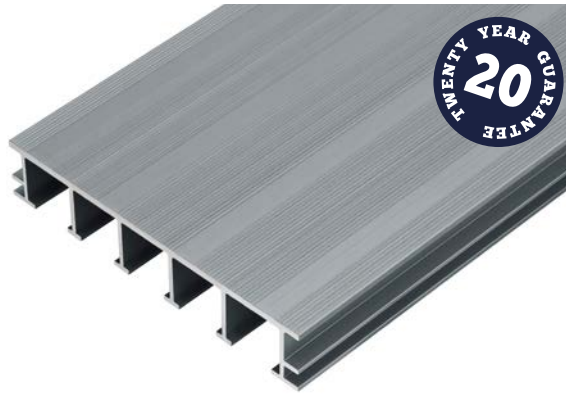

## AVAILABLE COLOURS

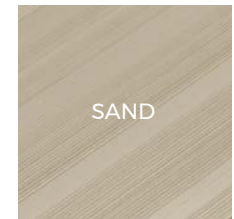
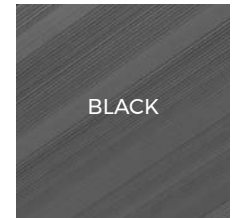

## ALUMINIUM DECKING JOIST

Aluminium Joists enable you to correctly install Aluminium Decking Boards upon a secure and supportive substructure, giving you a strong and professional finish.

### MEASUREMENTS

Length: 4m  
Size: 50mm x 50mm  
Weight: 4.04kg  
Colour: Black

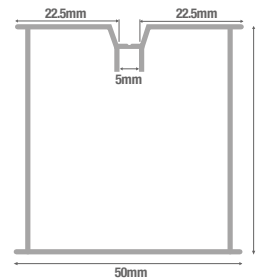

## ALUMINIUM DECKING ACCESSORIES



### STAINLESS STEEL STARTER CLIPS

Starter Clips allow for a precise fitting of your Aluminium Decking Boards.  
Pack Quantity: 50  
Recommended: 25mm stainless steel screws (not included)



### STAINLESS STEEL CLIPS & SCREWS

Stainless Steel Clips provide a hidden connection between Aluminium Decking.  
Pack Quantity: 100  
Supplied With: M4x30mm SS Screws



### ALUMINIUM SKIRTING TRIM

Hide any gaps or exposed edges for a long-lasting finish.

Length: 2.2m  
Height: 55mm  
Thickness: 3mm  
Colour: 5 Colours



### ALUMINIUM CORNER TRIM

Aluminium Corner Trims can conceal any exposed corners or edges.

Length: 2.2m  
Height: 55mm x 55mm  
Colour: 5 Colours

## JOIST SELECTION

We supply different Joist options for a variety of bases, such as grass, concrete and raised decks.

Composite Joists	Grass	Concrete/Solid	Raised	Timber Joists	Grass	Concrete/Solid	Raised
							
Structural Joists				Recycled Joists			

## COMPOSITE & RECYCLED PLASTIC FRAMEWORK

### CONCRETE BASE

When installing onto a concrete base, we advise the use of Composite or Structural Composite Joists.

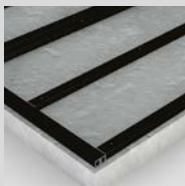

### RAISED FRAME

If installing a raised frame and looking for a Composite Joist, we advise using Structural Joists and Posts.

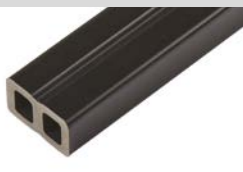

### COMPOSITE JOIST

Composite Joists can be used with Composite Decking or Cladding.

Length: 4m  
Height: 30mm  
Width: 50mm  
Weight: 5.16kg



### STRUCTURAL COMPOSITE JOIST

Structural Joists can be used with Composite or Nordeck Decking.

Length: 4m  
Height: 50mm  
Width: 100mm  
Weight: 17.24kg

### BENEFITS OF COMPOSITE JOISTS AND RECYCLED PLASTIC PRODUCTS



Environmentally-friendly materials.



Long-lasting, rot-free base.



Cut with standard woodworking tools.

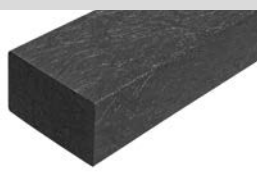

### RECYCLED PLASTIC JOIST

Plastic Joists are made with 100% recycled plastic materials. Use with Nordeck, Composite or Timber Decking.

Length: 3.6m  
Height: 50mm  
Width: 100mm  
Weight: 16kg



### RECYCLED PLASTIC JOIST

The wider Plastic Joist provides a lower base height overall. Use with Nordeck Composite or Timber Decking.

Length: 3m  
Height: 50mm  
Width: 150mm  
Weight: 20kg



### RECYCLED PLASTIC POST

Plastic Posts are made with 100% recycled plastic materials and are used to raise your Decking.

Length: 3m  
Height: 100mm  
Width: 100mm  
Weight: 27kg

### 100% RECYCLED PLASTIC PRODUCTS

These Joists and Posts are manufactured using 100% recycled plastics, using state of the art manufacturing technology. Our high-quality Recycled Plastic Joists and Posts come with a 20-year guarantee for peace of mind.



TIMBER FRAMEWORK



GRASS BASE

When installing onto a grass base, Heavy Duty Weed Mat will need to be secured underneath the Timber Joist framework to prevent any unwanted plants from growing through your Decking Boards.

RAISED FRAME

If you have a raised Decking area, use Timber Posts (100mm x 100mm) cut to the height of your Decking area and secure with screws to take the weight.

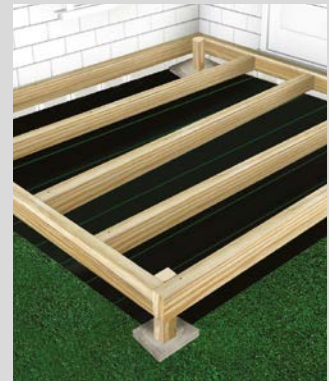

HEAVY DUTY WEED MAT

Prevent weeds from growing beneath your Decking and secure with fixing Pegs.

Length: 20m  
Width: 2m  
Thickness: 100gsm  
Weight: 7kg



WEED MAT GROUND PEGS

Large Ground Pegs to secure Heavy Duty Weed Mat beneath your Decking Boards.

Length: 15cm  
Pack quantity: 20



SAWN GREEN TREATED TIMBER POST

Timber Posts can be used in conjunction with Timber Joists for raised Decking.

Length: 3m  
Height: 100mm  
Width: 100mm



SAWN GREEN TREATED TIMBER DECKING JOIST

Timber Joists can be used with all Cladco Decking Boards.

Lengths: 4.2m & 4.8m  
Depth: 47mm  
Width: 150mm  
Weight (4.2m): 14.94kg  
Weight (4.8m): 17.07kg



SAWN GREEN TREATED TIMBER DECKING JOIST

Timber Joists can be used with all Cladco Decking Boards.

Lengths: 4.2m & 4.8m  
Depth: 47mm  
Width: 100mm  
Weight (4.2m): 11.38kg  
Weight (4.8m): 12.5kg



TYPE A GREEN TREATED TIMBER BATTEN

Lightweight Timber Joist for use with Decking or Cladding Boards.

Length: 4.8m  
Height: 25mm  
Width: 50mm  
Weight: 2.5kg



FRAME PROTECTION DECK TAPE

Non-butyl Deck Tape prevents rot and moisture damage to Timber Joists.

Length: 20m  
Width: 65mm

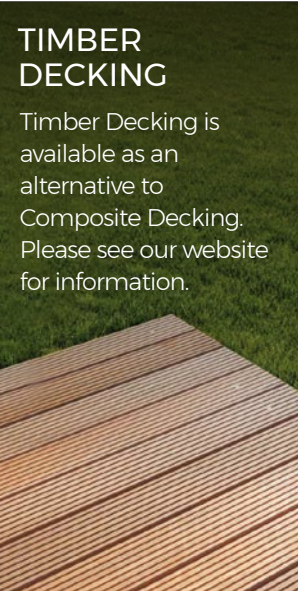

TIMBER DECKING

Timber Decking is available as an alternative to Composite Decking. Please see our website for information.



COMPOSITE DECKING TRIMS

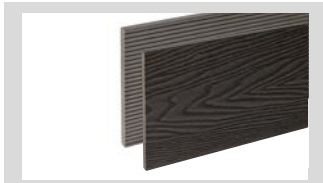

COMPOSITE FASCIA TRIM

Fascia Trims can be used with either a woodgrain effect or narrow groove side to suit your space.

Length: 2.4m  
Height: 146mm  
Width: 10mm  
Weight: 4kg  
Colour: 8 Colours



COMPOSITE SKIRTING TRIM

Composite Skirting Trims can be used as a Fascia Board to seal and finish a Decking area.

Length: 2.2m  
Height: 55mm  
Width: 10mm  
Weight: 1.4kg  
Colour: 8 Colours



COMPOSITE CORNER TRIM

Composite Corner Trims can be used to seal edges around doors, windows and external corners.

Length: 2.2m  
Height: 60 x 50mm  
Width: 10mm  
Weight: 2.1kg  
Colour: 8 Colours

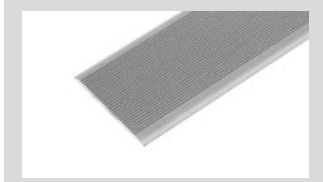

ALUMINIUM SKIRTING TRIM

Aluminium Skirting Trims can be used along the edges of Decking Boards for a metal finish.

Length: 2.2m  
Width: 55mm  
Depth: 3mm  
Weight: 2.2kg

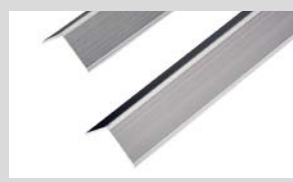

ALUMINIUM CORNER TRIM

Corner Trims can be used to create metal edging along exposed corners of Decking and Cladding installations.

Length: 2.2m  
Height: 55 x 55mm  
Weight: 2.5kg



HOLLOW DECKING END CAPS

Seal off the ends of Cladco Hollow Core Decking Boards with matching End Caps.

Pack quantity: 1  
Colour: 8 Colours

COMPOSITE TRIM COLOURS

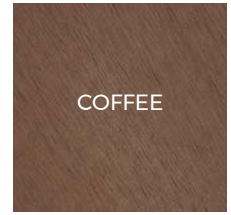

HOW TO FINISH OFF YOUR PROJECT

Complete your Cladco Composite Decking or Wall Cladding project with a selection of Trims and Composite Fascia Boards. Mix and match Trims and Boards using the range of eight Composite colours to create a bespoke design for your outdoor project.



DECKING ACCESSORIES



**STAINLESS STEEL CLIPS & SCREWS**

A hidden Clip system for use with Cladco Composite Decking Boards.

Pack quantity: 100  
Supplied with: M4x30 stainless steel wood screws



**T-CLIP FIXINGS AND SCREWS**

Easy-to-install T-Clips and Screws for use with Cladco Composite Decking Boards.

Pack quantity: 100  
Supplied with: Stainless steel wood screws



**SPEEDDEKZ 316 STAINLESS STEEL SCREWS**

Composite Decking Screws are available in two sizes and include a driver bit for your drill.

Lengths: 50mm & 65mm  
Pack quantity: 100



**STAINLESS STEEL STARTER CLIPS**

Starter Clips enable Cladco Composite Decking Boards to be installed close to a wall or boundary.

Pack quantity: 50  
Recommended 25mm stainless steel screws (not included)



**PHILLIPS IMPACT SCREWDRIVER BITS (MAGNETIC)**

Perfect for installing Composite Decking T-Clips and Stainless Steel Clips.

Size: PH2 x 65mm  
Pack quantity: 3



**SUMOG RIP ADHESIVE**

Odourless and solvent free, Sumogrip is environmentally-friendly. Its instant grab outperforms the majority of other grab adhesives.

Size: 290ml



**UNIVERSAL SEALANT GUN**

Cladco Sealant Gun can carry up to 310ml cartridges. The lightweight feel makes it perfect for using in tight areas.

Weight: 347g



**CTI SEALANT & ADHESIVE**

CTI seals, fills and bonds almost any material together, and is an all-in-one hybrid polymer.

Size: 290ml

DECKING AFTERCARE



**OWATROL COMPOSITE WOOD FINISH**

A water-based treatment that will increase the stain-resistance and water-proofing of Composite Decking.

Colour: Brown or Grey  
Size: 2.5L



**OWATROL DECKING CLEANER**

Degreasing water-based cleaning solution for Composite Decking and Cladding.

Colour: Clear  
Coverage: 5-10m squared per litre  
Size: 2.5L



**AFTERCARE GUIDES**

Visit our blog on our website to learn how to keep your Composite Decking Boards looking great throughout the year.

# Handrail Balustrade System



Can be painted to match your Decking



Superior strength and durability



Low-maintenance and non-corrosive



Lightweight and easy to install



Interchangeable lengths available



SCAN ME

## BALUSTRADE HANDRAIL

Cladco Powder-Coated Aluminium Balustrades are sturdy, attractive and durable alternatives to other Balustrade options available on the market, offering superior strength, longevity and peace of mind when used on a Decking project. The Balustrade Handrails, Gates and Posts are made from extruded and welded aluminium sections which are strong, low-maintenance and non-corrosive, powder-coated in black.

Our Balustrades can easily be re-painted to match your Decking installation or colour of choice. Balustrades are manufactured and sold as complete sections, no self-assembly is required and are easy to fit between Posts.

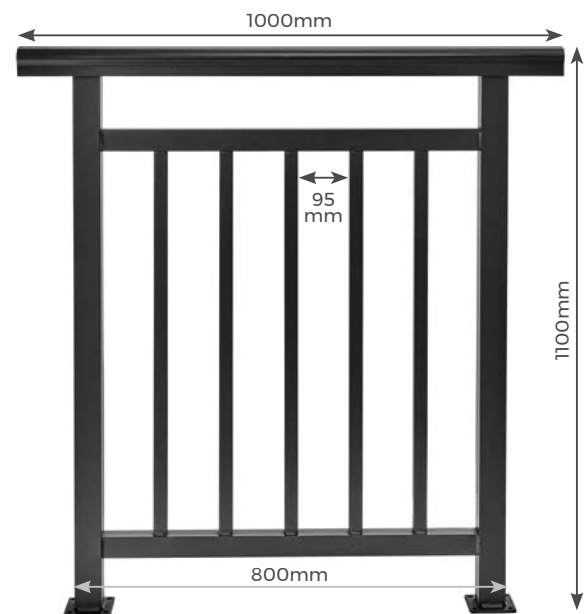

### MEASUREMENTS

Height: 1100mm  
Widths: 1000mm, 1200mm, 1400mm, 2200mm, 2400mm & 2600mm  
Material: Powder-Coated Aluminium



## BALUSTRADE POST

Cladco Balustrade Posts are low maintenance and manufactured with a non-corrosive powder coating in black. Our Balustrade Posts can easily be re-painted to match your Balustrade System or Decking colour.

Balustrade Posts are sold as complete Posts, no self-assembly is required. These Posts are easily installed to the Balustrade System and finished with a cap and foot piece.

The metal Balustrade Posts can be used with our Balustrade Handrails and installed on top of existing Decking for a solid, fixed boundary.

### MEASUREMENTS

Height: 1150mm with cap  
Width: 100mm x 100mm  
Material: Powder-Coated Aluminium

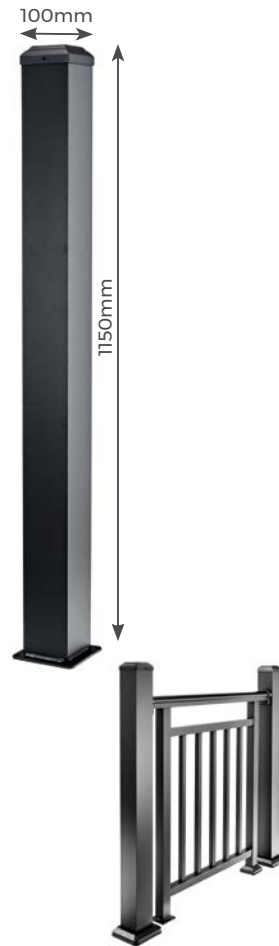

## BALUSTRADE GATE

The Aluminium Balustrade Gate is made from extruded and welded aluminium which is then powder-coated in black colour. Our Balustrade Gates can easily be re-painted to match your Decking installation or colour of choice.

Balustrade Gates are manufactured and sold as a complete Gate, no self-assembly is required and they are easy to fit between Balustrade Handrail sections.

Balustrade Gates can be used with Handrail sections and Posts for use alongside Decking installations, walkways, balconies and more. Complete your Gate installation using a Balustrade Latch and Hinge.

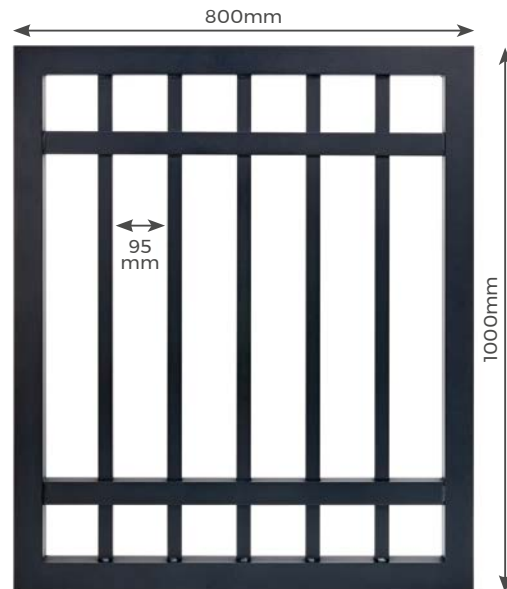

### MEASUREMENTS

Height: 1000mm  
Width: 800mm  
Material: Powder-Coated Aluminium



#### GATE HINGE

Self-closing Hinges for Gates up to 30kg (pack of 2).



#### GATE LATCH

Provides a safe, magnetic locking system for Balustrade Gates.

# Composite Wall Cladding



Cladco Composite Wall Cladding has the potential to completely transform your property. With Composite Cladding, you can make your project either blend into the surroundings, or stand out. Sometimes referred to as 'house cladding', Wall Cladding can instantly give a contemporary makeover to any type of building.

Composite Wall Cladding is a high-quality material suitable for covering exterior walls, which can instantly improve kerb appeal. Made

from 60% recycled hardwood fibres and 40% recycled plastics, materials are mixed together and then extruded to form either our Woodgrain Effect or Original Wall Cladding.

The benefits of mixing these two product groups allow you to end up with the durable, hard wearing, maintenance-free elements of the plastic and the beauty, look and feel of the wood, giving you a great looking product that will last for years to come.



No need to seal, stain or paint



Splinter, rot and warp resistant



Resistant to attack by insects



Low water absorption rate



Made with 100% recycled material



UV resistant colours



Easy to install



Sample Packs available to order



Wall Cladding Calculator

SCAN ME

Pictured - Charcoal Composite Wall Cladding





CLADCO

DECKING

EXTERNAL CLADDING

INTERNAL PANELLING

FENCING

INSTALLATION GUIDES

CASE STUDIES



SCAN ME

# COMPOSITE WALL CLADDING

## COMPOSITE WALL CLADDING

Composite Wall Cladding is a perfect way to make a statement and is a low-maintenance alternative to traditional timber cladding. Created with a combination of recycled wood and plastic, exterior Wall Cladding is easy to install either horizontally, or vertically, and can be used on a variety of wall materials.

Each Cladding Board gives 135mm coverage once installed. Read our easy-to-follow installation guide for more information.

### MEASUREMENTS

Length: 3.6m  
Width: 157mm  
Thickness: 20mm  
Weight: 6.95kg  
Colour: 8 Colours



## WOODGRAIN COMPOSITE WALL CLADDING

Cladco Woodgrain Effect Composite Wall Cladding provides an easy way to achieve that real wood effect without the effort, thanks to its attractive woodgrain pattern. This gives the appearance of natural wood while being low-maintenance. Boards do not need to be painted, stained, treated or sealed.

Composite Cladding is simple to install on an exterior wall in a horizontal or vertical pattern to transform a building.

### MEASUREMENTS

Length: 3.6m  
Width: 157mm  
Thickness: 20mm  
Weight: 6.95kg  
Colour: 8 Colours

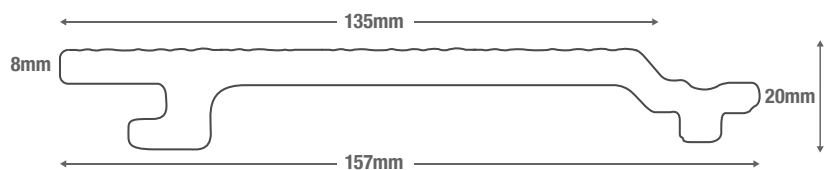

# WALL CLADDING ACCESSORIES



Composite Wall Cladding can be installed vertically or horizontally on your wall.

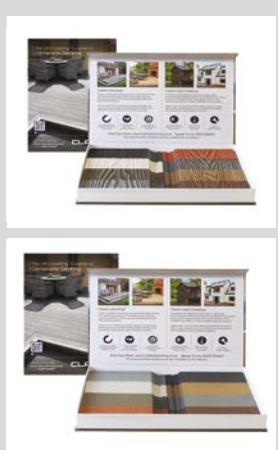

## WALL CLADDING SAMPLE PACKS

Sample Packs of Original and Woodgrain Wall Cladding are available.



## RECYCLED PLASTIC BATTEN

Recycled Plastic Battens can be used with the Cladco Wall Cladding range.

Length: 3m  
Height: 50mm  
Width: 50mm  
Colour: Charcoal  
Weight: 5.16kg

## AVAILABLE COLOURS

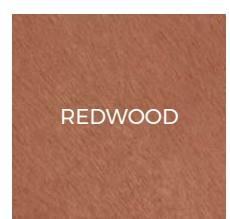
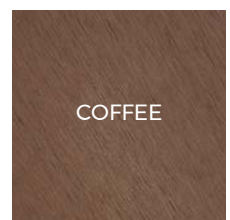
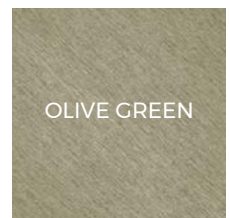
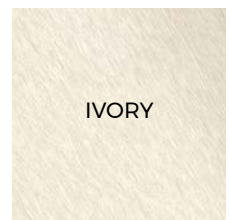
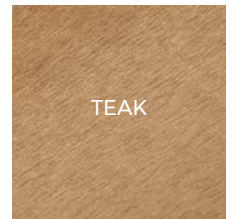

## COMPOSITE BATTEN

Composite Battens can be used with the Cladco Wall Cladding range.

Length: 4m  
Height: 30mm  
Width: 50mm  
Colour: Charcoal  
Weight: 5.16kg



## TIMBER TYPE A, TREATED BATTEN

Timber green treated Batten for use with Decking or Cladding installations.

Length: 4.8m  
Height: 25mm  
Width: 50mm  
Weight: 2.5kg



## COMPOSITE CORNER TRIM

Corner Trims can be used to seal open edges around doors, windows and external corners.

Length: 2.2m  
Height: 60 x 50mm  
Width: 10mm  
Weight: 2.1kg  
Colour: 8 Colours



## COMPOSITE SKIRTING TRIM

A Skirting Trim can be used as a Fascia Board to seal and finish any Wall Cladding area.

Length: 2.2m  
Height: 55mm  
Width: 10mm  
Weight: 1.4kg  
Colour: 8 Colours



## WALL CLADDING STARTER STRIP

Starter Strips can be used to ensure a level edge to begin the Cladding installation.

Length: 3m  
Height: 50mm  
Depth: 10mm  
Weight: 1.32kg



## CTI SEALANT & ADHESIVE

CTI seals, fills and bonds almost any material together, as an all-in-one hybrid polymer.

Size: 290ml  
Colour: 9 Colours

# Composite Slatted Wall Cladding



Cladco Composite Slatted Wall Cladding Panels offer a contemporary cladding solution for exterior walls. Manufactured using a capped composite construction, each Panel features a subtle textured grain effect across four slats.

Composite Slatted Panels are designed with a tongue-and-groove fitting, with overlapping edges. This installation method hides fixings for a discreet finish. Please see our Installation Guide on our website.



Resistant to attack by insects



Anti-UV agent resists colour fade



Easy to install



Sample Packs available to order



SCAN ME

Pictured - Charcoal Composite Slatted Wall Cladding

## COMPOSITE SLATTED PANELS

Composite Slatted Cladding Panels can be installed either horizontally or vertically. Panels are suitable for installations on both domestic and commercial applications for an attractive, exterior statement wall.



## AVAILABLE COLOURS

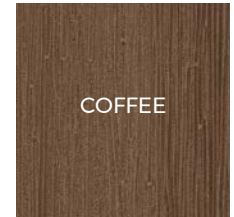
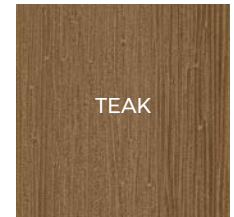
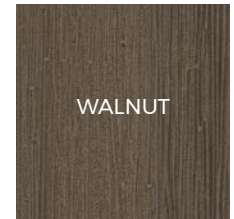

## MEASUREMENTS

Length: 2.5m Width: 220mm (200mm when lapped)  
 Thickness: 26mm Weight Per Panel: 7.58kg  
 Colour: 6 Colours

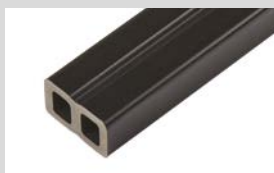
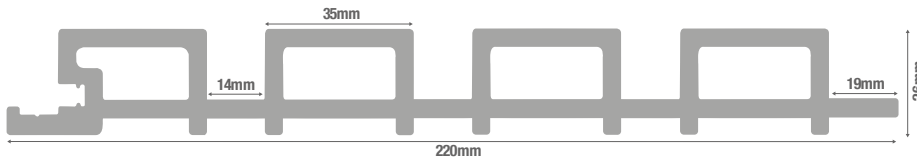

### COMPOSITE BATTEN

Composite Battens can be used with the Slatted Wall Cladding range.

Length: 4m  
 Height: 30mm  
 Width: 50mm  
 Colour: Charcoal  
 Weight: 5.16kg



### SINGLE START TRIM

Begin your Cladding design with Capped Composite Single Start Trims.

Length: 2.5m  
 Height: 26mm  
 Width: 49mm  
 Colours: 6  
 Weight: 1.5kg



### DOUBLE END TRIM

Finish your Wall Cladding project with Capped Composite End Trims.

Length: 2.5m  
 Height: 26mm  
 Width: 105mm  
 Colours: 6  
 Weight: 3kg



### EXTERNAL CORNER TRIM

Create a long-lasting edge along exterior corners.

Length: 2.5m  
 Height: 26mm  
 Width: 49mm  
 Colours: 6  
 Weight: 3kg

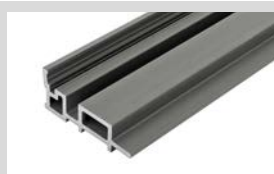

### INTERNAL CORNER TRIM

Continue your Slatted Wall Cladding design around internal corners.

Length: 2.5m  
 Height: 26mm  
 Width: 39mm x 95mm  
 Colours: 6  
 Weight: 3kg

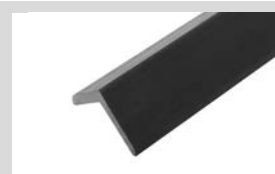

### CAPPED CORNER TRIM

Used to hide exposed ends of Slatted Cladding Panels.

Length: 2.5m  
 Height: 45mm  
 Width: 45mm  
 Colours: 6  
 Weight: 1.75kg



## SAMPLE PACKS AVAILABLE

Samples are available from our website.

# Fibre Cement Wall Cladding



Made from advanced material fibre cement, Cladco Fibre Cement Cladding is an engineered cellulose-fibre and cement material that offers the ultimate in moisture, rot and pest resistance. The unique properties of Cladco Fibre Cement Cladding offers major advantages over conventional cladding materials, providing ease of installation, design flexibility

and enhanced durability.

With advanced seventh generation technology, we have created a high-end durable alternative to timber. The enhanced properties within this product ensure it has increased strength and durability. The additives within this product are chemically bonded to provide lasting resistance to weather conditions.



Painted or unpainted options available



Extensive selection of colours



Easy to install in a horizontal feather board effect



Simply wash with soap and water



Dimensionally very stable



Samples available to order



SCAN ME



Wall Cladding Calculator

Pictured - Blue Fibre Cement Wall Cladding





CLADCO

DECKING

EXTERNAL CLADDING

INTERNAL PANELLING

FENCING

INSTALLATION GUIDES

CASE STUDIES



SCAN ME

# FIBRE CEMENT WALL CLADDING

## FIBRE CEMENT WALL CLADDING BOARDS

Fibre Cement Wall Cladding Boards have a durable, embossed wood effect appearance benefitting from being low-maintenance and increased durability compared to traditional timber. The unique properties of our Fibre Cement Cladding offer major advantages over conventional timber materials, providing ease of installation and enhanced durability. Available in a range of eight colours as well as an Unpainted option, and suitable for domestic and commercial applications.



### MEASUREMENTS

Length: 3.66m Width: 210mm  
Thickness: 8mm  
Colour: 8 Colours and Unpainted



## FIBRE CEMENT ACCESSORIES

Ensure your Fibre Cement Wall Cladding project has the correct Trims for a seamless, contemporary and durable installation. Aluminium Fibre Cement Wall Cladding Trims are colour matched for a high-quality finish.

### TRIMS

#### SYMMETRIC EXTERNAL CORNER TRIM

Designed to fit on the corners of the building, Fibre Cement Wall Cladding Boards are installed to the flat edges of the Trim.

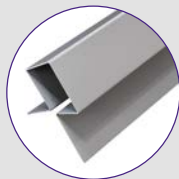

#### INTERNAL CORNER TRIM

Used in the internal corners of a building for a neat, seamless finish.

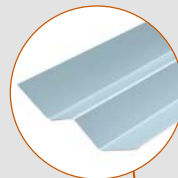

#### WALL END TRIM

Installed on the finishing edge to conceal exposed ends of Fibre Cement Wall Cladding Boards.

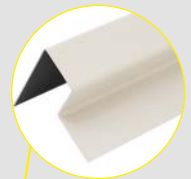

#### SINGLE & DOUBLE CONNECTION TRIMS

Installed to the inside edges of window reveals and door frames to support Boards.

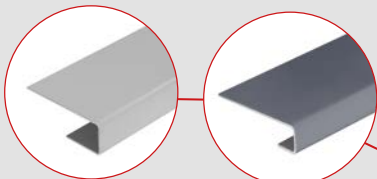

#### PERFORATED CLOSURE

Installed under the Battens at the base of the build, or at the top of any doors and windows, to ensure ventilation throughout the installation. Perforated Closure also protects the build from any dirt or insects penetrating the air flow space.

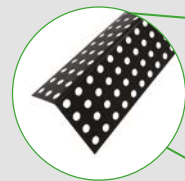

#### START TRIM

Installed at the start of new Board runs at the base of the building.

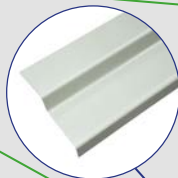

#### ASYMMETRIC EXTERNAL CORNER TRIM

Designed to be installed on either side of the door or window, allowing Boards to be fitted on the flat surface of the Trim.

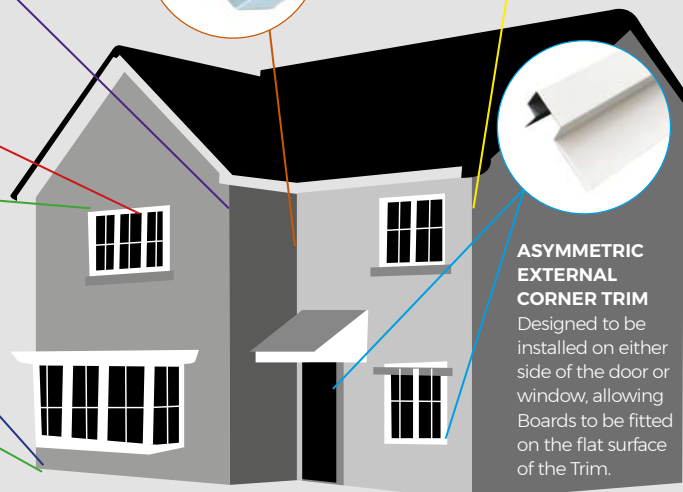

### WALL CLADDING SAMPLE PACKS

Sample Packs of our Fibre Cement Wall Cladding are available. Choose two of the available nine options.



### FIBRE CEMENT TOUCH-UP PAINT

Cover up any marks or chips on Fibre Cement Wall Cladding Boards. Size: 500ml Colour: 8 Colours





FIBRE CEMENT ACCESSORIES AND TRIMS



**RECYCLED PLASTIC BATTEN**

Length: 3m  
Size: 50mm x 50mm  
Colour: Charcoal  
Weight: 5.16kg



**39MM STAINLESS STEEL SCREWS**

Size: 39mm plus drill bit  
Pack: 100  
Colour: 7 Colours



**M4 X 40MM STAINLESS STEEL**

Size: 40mm  
Pack: 100  
Head Type: PH2



**SYMMETRIC EXTERIOR CORNER**

Length: 3m  
Measurements: 26mm x 31mm x 31mm x 26mm  
Thickness: 1mm  
Weight: 1.53kg



**SINGLE BOARD CONNECTION TRIM**

Length: 3m  
Measurements: 45mm x 10mm x 8mm  
Thickness: 1mm  
Weight: 1.53kg



**DOUBLE BOARD CONNECTION TRIM**

Length: 3m  
Measurements: 48mm x 18mm x 20mm  
Thickness: 1mm  
Weight: 1.53kg



**PERFORATED CLOSURE**

Length: 3m  
Height: 30mm  
Width: 40mm  
Thickness: 1mm  
Weight: 0.5kg



**WALL END PROFILE TRIM**

Length: 3m  
Measurements: 64mm x 26mm x 27mm x 30mm  
Thickness: 1mm  
Weight: 1.53kg



**INTERNAL CORNER TRIM**

Length: 3m  
Measurements: 35mm x 25mm x 35mm x 25mm  
Thickness: 1mm  
Weight: 1.53kg



**START TRIM**

Length: 3m  
Measurements: 30mm x 10mm x 30mm x 7mm  
Thickness: 1mm  
Weight: 1.53kg



**ASYMMETRIC EXTERNAL CORNER**

Length: 3m  
Measurements: 13mm x 31mm x 31mm x 26mm  
Thickness: 1mm  
Weight: 1.53kg



**ALUMINIUM FLAT SHEETS**

Size: 3m x 1250mm  
Colour: 8 Colours  
Thickness: 1mm  
Weight: 11kg

AVAILABLE COLOURS



# Internal Slatted Wall Panels

Transform the look and feel of your home's interior walls with Cladco Internal Slatted Wall Panels.

Manufactured from wood-veneered MDF slats built onto a recycled PET felt base (formed using post-consumer plastic bottles), our Slatted Panels replicate the look and feel of individual timber slats and are easy to install with either nails, screws or wood grab adhesive. Each Panel can be fitted either horizontally or vertically and is available in seven colours.



Recycled PET felt base



Easy to install



Made from wood-veneered MDF



Versatile design options



Authentic woodgrain effect surface



Sample Packs available to order



SCAN ME

Pictured - Golden Pine Internal Slatted Wall Panels

# INTERNAL SLATTED WALL PANELS

## INTERNAL SLATTED WALL PANELS

Internal Slatted Wall Panels are manufactured from wood-veneered MDF and feature an authentic woodgrain surface. Panels are built onto a recycled PET felt base (made from post-consumer plastic bottles) that provides a lightweight yet durable interior solution.

Internal Slatted Wall Panels are quick to secure onto interior walls using nails, screws or wall grab adhesive and can be installed either horizontally or vertically to create a bespoke look around any existing wall feature.



## AVAILABLE COLOURS

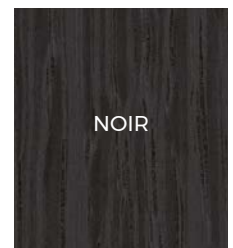

## MEASUREMENTS

Length: 2.4m  
Width: 600mm  
Thickness: 21mm  
Weight: 12.5kg  
Colour: 7 Colours



## 2.4m Panel Diagram

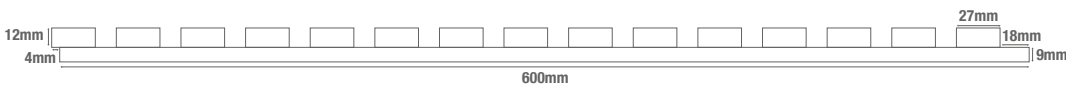

## WALL PANELLING SAMPLE PACKS

Sample Packs of our Internal Slatted Wall Panels are available. Choose two colours of your choice.



## FIBRE CEMENT BACKER BOARD

Cladco Fibre Cement Backer Board is a multipurpose construction material to replace ply or plasterboard alternatives.



## INTERNAL SLATTED WALL PANEL

Length: 0.6m  
Width: 600mm  
Thickness: 21mm  
Weight: 3.13kg  
Colour: 7 Colours

# Composite Fencing

Cladco Composite Fencing Panels are one of the latest innovations in Composite technology, offering superior strength and durability against timber options on the market.

Composite Fencing Panels are suitable for use in domestic or commercial applications and are easily installed using matching Cladco Composite Posts.



No need to seal, stain or paint



Splinter, rot and warp resistant



Resistant to attack by insects



Low water absorption rate



Made with 100% recycled material



Sample Packs available to order



SCAN ME



## Measuring Cladco Fencing Posts

**Please note:** due to variations within the manufacturing process of Fence Posts, we advise to **measure a 20mm** channel rather than using the lines on the Posts, if installing the Panels using the slot between method. If installing by securing to the front of the Post, this process does not need to be followed.

Pictured - Stone Grey Fencing Panels with Charcoal Fencing Posts and Caps

## COMPOSITE FENCING PANEL

Composite Fencing Panels are a strong, long-lasting durable alternative to timber and can be easily installed in any outdoor project. The innovative honeycomb core structure gives the Panels increased strength.

### MEASUREMENTS

Length: 3.6m  
 Height: 210mm  
 Thickness: 20mm  
 Weight: 11.52kg  
 Colour: 4 Colours

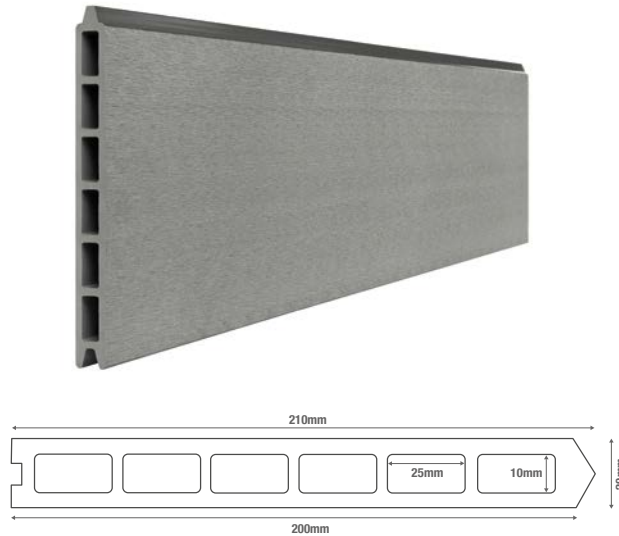

## AVAILABLE COLOURS

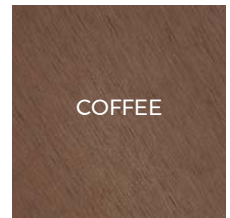
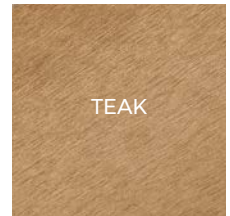

## COMPOSITE FENCING POST

Composite Fencing Posts are designed for use with our Composite Fencing Panels and can be cut to a 20mm channel for Panels to slot into. Each Post comes in a 3m length and in a choice of four colours.

### MEASUREMENTS

Length: 3m  
 Size: 100 x 100mm square  
 Weight: 16.5kg  
 Colour: 4 Colours



## FENCING ACCESSORIES



### COMPOSITE FENCE POST CAP

Designed to sit on top of our Composite Fencing Posts to finish off your project.

Height: 22.5mm  
 Width: 108mm  
 Length: 108mm  
 Colour: 4 Colours



### CONCRETE POST SPACER

Metal Concrete Post Spacer reduces the 50mm panel groove in concrete posts to 21mm, to allow for Composite Fence Panels.

Length: 3m  
 Thickness: 1mm



### COMPOSITE FENCING RAIL

Steel Fencing Rails simply clip onto the top or bottom of your Composite Fence Panels. Available in a range of colours.

Dimensions: 20mm x 20mm x 18mm  
 Thickness: 0.6mm-0.7mm  
 Length: 2m



## Protective Equipment

When handling or carrying Decking Boards, Fencing or Wall Cladding, it is advised to wear long sleeves and gloves. When cutting the Boards, we recommend wearing a protective dust mask, ear defenders and safety glasses. Knee pads are recommended to be worn when fitting Decking. Visit the Health and Safety Executive's website [www.hse.gov.uk](http://www.hse.gov.uk) for more information on how to work safely.



## Tool Set

Standard everyday carpentry tools will be needed to complete the installation, including: tape measure, pencil, spacing tools, and stanley knife.



## Power Drill or Driver

Standard power drills can be used when installing Cladco products. A standard Phillips PH2 Screwdriver Bit should be used when working with Speeddekz 65mm Screws and Speeddekz 50mm Screws.



## Sumogrip Adhesive

We recommend using Sumogrip or CTI Adhesive to secure our Fascia Boards when concealing a support system beneath. When using adhesive, do not allow the adhesive to get on the surrounding products, as this can damage the finish of the installation.



## Jigsaw / Handsaw

Decking Boards, Fencing and Wall Cladding can be cut using any standard wood cutting tools. We recommend using a fine toothed blade to get the cleanest finish to your cut edge.



## Spirit Level and String

A spirit level is essential when installing your Decking, Wall Cladding or Fencing, to ensure a level support system. A spirit level ensures the products are installed along a straight edge. A slight slope should be installed on Decking installations to allow for water run-off.



## Storage and Handling

Cladco products should always be stored in a cool shaded spot, on a flat and level surface which supports the whole length of the Boards. It is recommended to store the products on a pallet to ensure they are not sat directly on wet or cold ground.

Wear protective gloves when handling the products and take care when lifting them. We recommend that a minimum of two physically capable persons carry the Boards. Always ensure any persons assisting with installation, or handling, is physically able.

Please note: the information within these Guides should be used as a guide and due care and attention must be met. Always consult a professional before installation.

# Installation Guides

Installation Guides are available for all product ranges. Please see our website to download these Guides, or visit our YouTube channel to watch a simple animation.

CLADCO

DECKING

EXTERNAL CLADDING

INTERNAL PANELLING

FENCING

INSTALLATION GUIDES

CASE STUDIES



# COMPOSITE DECKING AND FRAMEWORK Installation Guide

Pictured - Stone Grey Grooved Reversible Composite Decking Boards



SCAN ME

## PREPARE YOUR BASE

### Building your Decking on concrete?

Make sure that the area to be decked is flat and stable. The concrete base should be at least 10cm thick and have a slight slope - we suggest a gradient of 1 in 80 - that runs away from the property to allow for the run-off of water that collects under the Decking Boards.

We advise installing Composite Decking Boards onto Cladco Recycled Plastic Decking Subframes, and in accordance with our Installation Guide, to qualify for a 15-year guarantee.



1 Remove the turf or soil until the ground is completely even, removing any debris or rocks. Cover the area with a layer of Weed Mat. If you need to overlap the Weed Mat, ensure you do this with enough fabric to prevent any gaps. Pin in place and cover with chippings, bark, or stones.

### AIRFLOW

Ensure your substructure design allows for significant airflow and ventilation. If the Decking is being installed on areas with poor

ventilation, the Decking must be installed on top of a substructure which allows for a 47mm airflow gap.





## FRAMEWORK

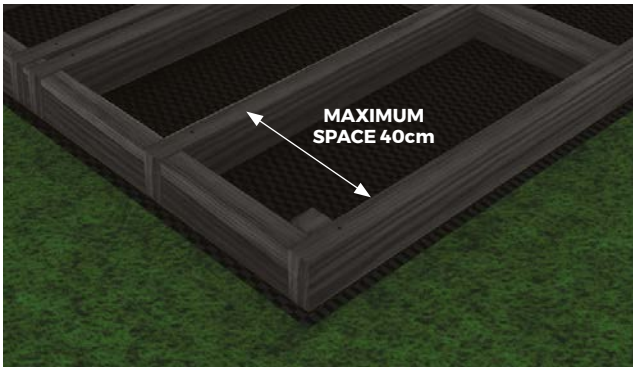

**2** Recycled Plastic Joists can be installed directly over grass ensuring that Weed Mat is laid underneath. Alternatively, a raised substructure can be installed using Recycled Plastic Posts. The maximum recommended space between Joist rows depends on the angle at which you intend to lay your Boards in relation to the Joists, but should **never exceed 40cm**.



**3** Starter Clips need to be fixed to the end of the Joists before laying the first Board. Place these at the end of each Joist, leaving a gap of 15mm between the wall and the Starter Clip to allow for expansion.



**4** Our Composite Boards are easily fastened to the Joists of a supporting substructure with the help of our Stainless Steel Screw and Clip System. Start at the outside of the area to be decked. Place your first Board and fix it to each Joist it crosses using a row of Starter Clips.

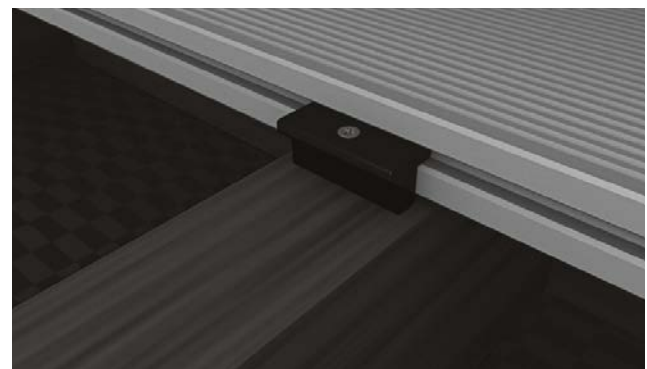

**5** Slot Clips into the groove along the side of the Board and screw them into the supporting Joists with the screws provided, using one Clip for each supporting Joist. We recommend you use our Stainless Steel Wood Screws offering increased wear and less corrosion. T-Clips will leave a 7mm gap between Boards.

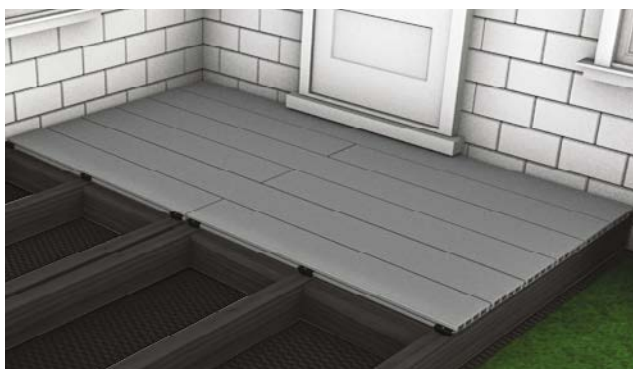

**6** Fit your next Board by sliding it onto the Clips used to secure the first Board and fitting another set of Clips to secure the opposite side of the Board, using one Clip for each supporting Joist. Follow a similar process to fix subsequent Boards. The ends of Boards must be fully supported. No overhang or cantilever is advised.



**7** At butt joints - where the ends of two Decking Boards meet - you will need to ensure that each Board is held in place with its own Clip where they meet. Please ensure you leave adequate gaps for expansion and contraction of the Boards, in most cases this will need to be at least 7mm.

# COMPOSITE DECKING INSTALLATION GUIDE



**8** Having fastened your Boards, all that remains is to tidy up the sides of your new Deck with our Composite Skirting or Fascia Boards, which can be used to hide the unfinished ends of Boards and supporting Joists.

**9** Our Hollow Decking End Caps are used to seal off the ends of Hollow Core Boards to give your Decking a professional finished look. End Caps are available in the same colours as all our Composite Decking Boards. Apply them to neatly complete your Decking project.



**TOPTIP** Consider using Cladco Stainless Steel Clips and Screws to give a more discreet, 3mm gap between Boards.

## FINISHING YOUR DECKING

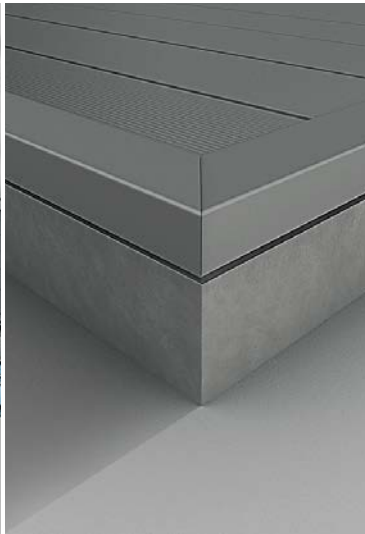
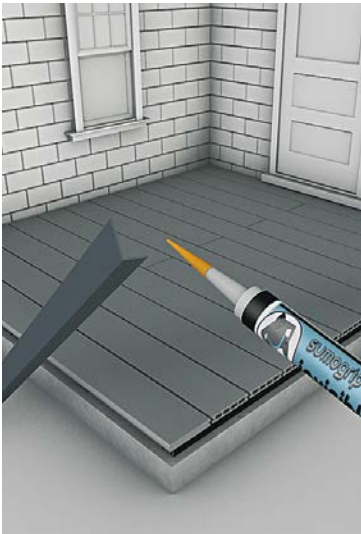

### HOW TO INSTALL FASCIA BOARDS, SKIRTING OR CORNER TRIMS

Using 50mm SPEEDDEKZ Deck Screws, fix the ends of Fascia Boards or Corner Trims to the Joists or Boards behind. Ensure the Screws are inserted 13mm from the edge of the Fascia Board or Trim. Continue fixing 300mm after each Screw. Alternatively, you can use a strong adhesive (CTI) to secure the Boards or Trims. For optimum results, alternate between Screws and adhesive every 150mm until the Board or Trim is fastened securely.

### HOW TO INSTALL BULLNOSE BOARDS

Using Speeddekz 65mm Wood Screws, insert at an angle through the supporting Joist underneath the Board. Ensure the Bullnose Board is supported along the length, with Joists and a Screw inserted into each one. Two Screws are recommended across the width of the Board at regular intervals, inserted 13mm from the edges of the Board. After securing the front of the Board, secure the centre into the Joist below, followed by the end of the Board. Once the Board is securely in place, fix the Board at several intervals. We recommend using 11 Screws per 4m Board, with a T-Clip to secure internally.

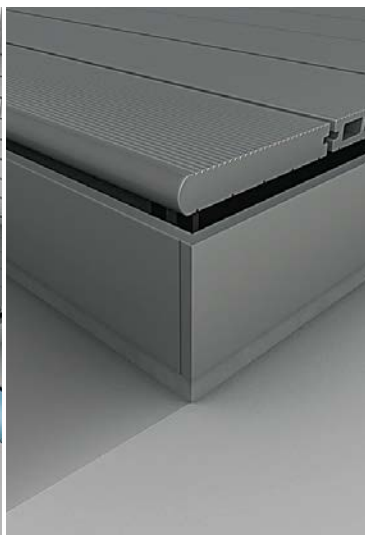
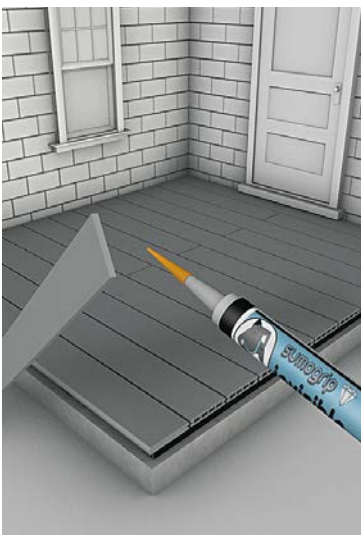

# NORDECK DECKING Installation Guide

Pictured - Silver Birch Nordeck Woodgrain Effect Decking Boards



SCAN ME

## PREPARE YOUR BASE

### CHOOSE FROM TWO BASES



#### CONCRETE BASE

A 100mm thick concrete base is recommended, with a slight slope for drainage to occur. The optimum slope should be around 5mm for every metre. Timber Joists then can be secured to the concrete base.



#### GRASS OR SOIL BASE

Remove the turf or soil until the ground is completely even, ensuring to remove any debris or rocks from the area. Cover the area of your site with a layer of our Weed Mat, to prevent any weed re-growth coming up under your Decking. If installing on a grass or soil base, you can use Timber Joists, Recycled Plastic Joists, or Structural Composite Joists, as per the Installation Guide.



#### AIRFLOW

Ensure your substructure design allows for significant airflow and ventilation. If the Decking is being

installed on areas with poor ventilation, the Decking substructure must be installed on top of Joists which allow for a 47mm airflow gap.

## FRAMEWORK



**1** Prepare a level, weed-free area for the deck. To create a framework, cut the Joists (47mm x 100mm or 47mm x 150mm) to the required length, then join using Wood Screws. Check the frame is square, by measuring diagonally from corner to corner. If installing on grass or soil, use Weed Mat to ensure weeds do not grow through from the base of the Decking frame.



**2** To raise the frame, cut four blocks of 100mm x 100mm treated timber to the desired height. Screw these to the inside of the frame at each corner, ensuring they are flush with the top. These legs will be taking all the weight for now, so ensure they are properly supported using blocks and secured to the frame.



**3** If your deck will be sitting on grass or soil, you will need to place blocks or slabs underneath each leg, to spread the load and provide a level, stable base. Additional blocks can be used if required. Position and adjust the blocks/slabs, ensuring the frame is at a slight angle to allow the water to drain down the length. We recommend a slope of at least 5mm for every metre. Alternatively, if using slabs, you could dig a hole and set the legs in concrete.



**TOP TIP** Cut two blocks to the width required and use as spacers for the Joists.

**4** Mark across one side of the frame every 300mm to set your Joists at the recommended required 300mm centres, then repeat the process on the opposite side of the frame. You may wish to set your Joists to less than 300mm centres, to ensure even spacing of the Joists across the frame. You will need to have a double Joist in areas where the ends of two Boards meet.



**5** Measure across the inside of the frame at your Joist marks, then cut lengths of 47mm x 100mm or 47mm x 150mm timber to suit. To fix the Joists, tap them in with a hammer until flush with the top, ensuring they do not push the frame out of shape. Then screw them in place from the outside of the frame. Apply Deck Tape to the top surface and cut ends of Joists to protect them from moisture.

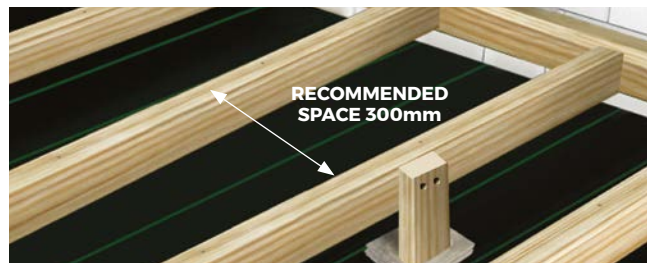

300mm Joist spacings are recommended (never exceed 400mm spacings).

**6** Support the Joists with additional 100mm x 100mm legs, spaced at 1m maximum intervals. Follow the same method as shown in steps 2 and 3 for these legs, ensuring each is supported by a suitable block, slab or concreted into the surface below. Use additional supporting legs for the outer frame ensuring the whole area is supported.

# LAYING THE DECKING BOARDS



## EXTREME TEMPERATURES

Extreme temperature changes could cause the Boards to expand or contract. Ensure Boards have had sufficient time to acclimatise to the temperature before installing. Do not install in extreme temperatures.



## CUTTING

If Boards need to be cut to size, ensure the Boards are installed and secured immediately after cutting.



**7** Start by laying out your Decking Boards onto the desired area before fixing them in place. Ensure there is a 3mm gap between any Boards at butt ends or side by side and between all walls and fences.

Check all Boards fit and you are happy with the layout. Cut Boards must always be positioned over and fastened to a supporting Joist. Each Board will cover an area of 0.72m<sup>2</sup>.



### TOP TIP

To protect the woodgrain effect, use a rubber mallet to insert the colour plugs over the screw heads in your Nordeck Decking Boards.

**8** Secure one end of the Board into the structural base below using Cladco Hidden Deck Fasteners with the supplied drill bit and Plugs.

Screws should be inserted 13mm away from the edges of the Board. Apply pressure using the supplied drill bit to compress the orange pad onto the surface of the Board to create space for the Plug. The supplied Plug can then be inserted to create a flush, hidden finish over the Screw head to conceal it.

A row of 65mm Screws with Plugs should be fixed down the entire width of both sides of the Board at regular intervals over Joists, positioned 13mm from the outside edges.

Alternatively, Nordeck Decking Boards can be secured to Joists using Cladco 65mm SPEEDDEKZ Decking Screws. Please note that using this type of screw will show the head.

Around 26 screws should be used per 3.6m Board. After installing each Board ensure they are lined up correctly until the deck is complete.



## PAINING THE EXPOSED ENDS

You may wish to paint the end of Nordeck Decking Boards to hide the grey core interior. We recommend using an exterior grade acrylic water-based paint.

## FINISHING YOUR DECKING



### TO INSTALL YOUR BULLNOSE BOARDS

Measure the edge of your Decking project and cut the Bullnose Board to the length required.

Using Speeddekz 65mm Wood Screws, secure one end of your Board to the Joist below. Two Screws are recommended across the width of the Board at regular intervals. Screws should be inserted 13mm from the edges of the Board. After securing the front of the Board, secure the centre into the Joist below, followed by the end of the Board. Once the Board is securely in place, fix the Board at several intervals. We recommend using 26 Screws per 3.6m Board.



### TO INSTALL YOUR FASCIA

Using 50mm Speeddekz Screws, fix the ends of your Fascia Board to the Joist behind. Ensure the Screws are inserted 13mm from the edge of the Board. Continue fixing Screws 300mm after the first Screw.

Alternatively, you can use a strong adhesive (Sumogrip) to secure the Board. For optimum results, alternate between Screws and adhesive every 150mm until the Board is fastened securely.



### SUMOGRIP

When using the Sumogrip Adhesive, do not allow the adhesive to get on the surface of the Decking Boards, as this can damage the finish of the deck.



### FASCIA BOARDS

Once the Bullnose Boards have been installed, you may wish to add matching Fascia Boards to the Decking installation. Fascia Boards can be fitted to the exposed Structural Joists, hiding the base below.



### BULLNOSE DECKING BOARDS INSTALLED ON STEPS

Bullnose Decking Boards are a great way of finishing your Decking area, either as an edge Board on an installation, or as steps on a raised project.

Pictured - Cedar Wood Nordeck Woodgrain Effect Decking Boards

# COMPOSITE WALL CLADDING Installation Guide



SCAN ME

Pictured - Stone Grey Composite Wall Cladding Boards

## PREPARE YOUR WALL

### Installing Vertically Or Horizontally?

Composite Wall Cladding can be installed vertically or horizontally. It is recommended that the Battens used to support your Wall Cladding are made from Composite or Recycled Plastic material as this helps to maximise the long term performance of your Cladding. Alternatively, you can use Timber to support your Cladding following the same fitting process as you would for Composite Battens.

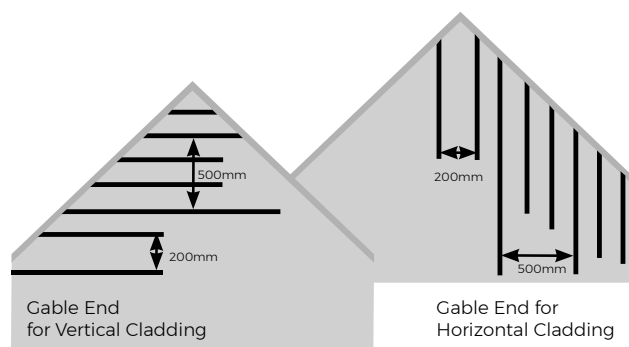

**1** Install your Battens at a 90-degree angle to the way that you want your Wall Cladding Boards to run. It is important that the surface below is flat and stable. Pre-drill the Battens and the surface using a 6mm drill bit. Composite Battens are 30mm high and should be secured at least 50mm into the surface. Screws should be 5-6mm in diameter and at least 80mm long\*.

Secure Battens to the surface at a maximum distance of 500mm apart. Ensure your Battens run the entire length of the area being clad. Add in additional Battens where two Cladding Boards meet end to end.

\*We do not provide the fixings and screws for your installation.

**2** Install 30mm x 50mm Composite Battens flush to the wall, creating an adequate ventilation gap between the wall and the Composite Cladding Boards. Battens must be no more than 500mm apart, reducing to 400mm at boundary areas.

If your home has a gable end, Battens must be spaced up to 500mm apart with additional, shorter supporting Battens installed every 200mm, going up and down the apex (the triangular shape of your gable end). This ensures the Composite Boards are fully supported across the entire build. Ensure all Battens are vertical and level using either a tape measure or a spirit level before installing Boards.

## COMPOSITE WALL CLADDING INSTALLATION GUIDE

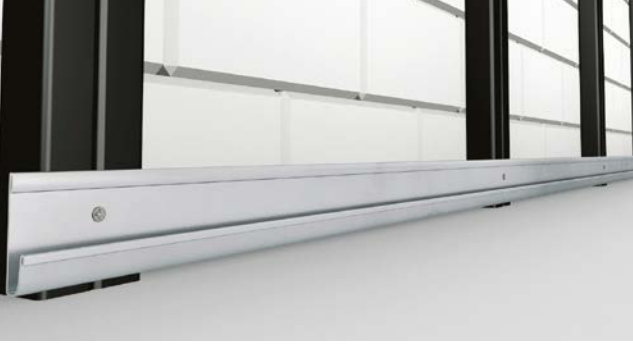

**3** Attach a Starter Strip to the bottom of each Batten, this will give the first Cladding Board something to sit on. You will need to pre-drill a pilot hole into the Batten and attach the Starter Strip using a screw that is at least 15mm long. Ensure that each Strip is level with the next and that the first Board sits level on the Strips before continuing to the next step. Place the first Wall Cladding Board on to the Starter Strips. Mark and then pre-drill pilot holes through the fixing groove of the Board into the Batten below.



**4** Secure the Boards using a screw at least 20mm in length, ensuring that the Board is fastened securely on each Batten that it touches. Secure these fixings by hand, it is important not to over-tighten the screws and risk splitting the Board. Ensure that the section between the Battens remains empty allowing air to flow beneath the Boards.

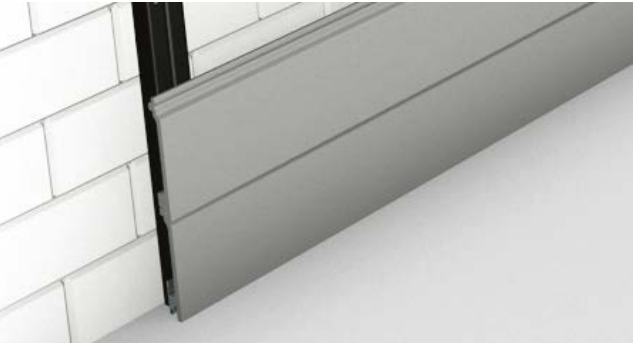

**5** Slot the second Board onto the first and repeat the fixing process ensuring that the second Board is fitted securely in place on each Batten. Repeat this process with each Board until you reach the required height.

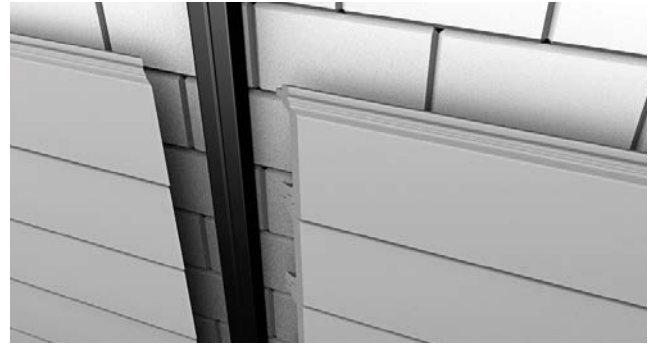

**6** When butting two Boards together, you should use a mitered edge for a neat finish. The most common miter angle is 45 degrees. As the cuts are angled, you'll have one side of the wood longer than the other. You'll need to keep track of which side will be which and make your measurements correctly.



**7** Set the miter saw to the angle it will need to cut at. Use the included instructions for your machine, as each is different. Set the pieces side by side to ensure a neat joint. Screw the Wall Cladding through the top and into the Batten.



**8** Continue to fit the Cladding Boards in this manner until you have completely covered the area you want. It is possible to fit your Boards end-to-end by simply butting the two ends together. You may need to install more Battens if you wish to do this as, each Board will need to be supported on a Batten where it meets the next Board.



# FINISH OFF YOUR CLADDING

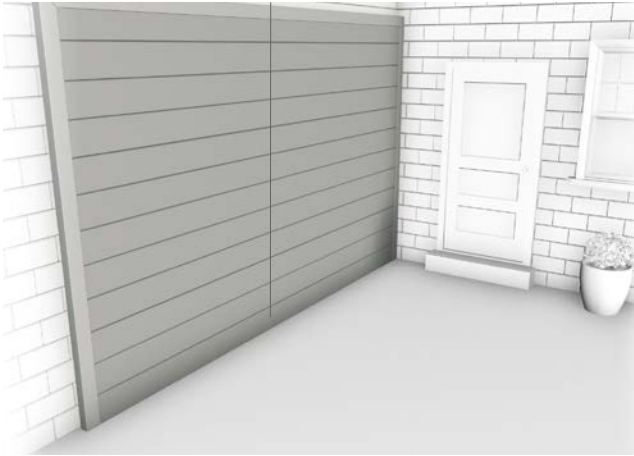

Depending on your installation, you may want to finish off the edges using Composite Trims to give you a lasting professional look. There are a range of Trims available in all colours to complement your Cladding Boards and these can be secured to your installation by gluing them in place using an exterior grade high elastic glue.

Do not completely seal your installation, allow some air to flow between the Cladding Boards and the surface below when fitting the trims.

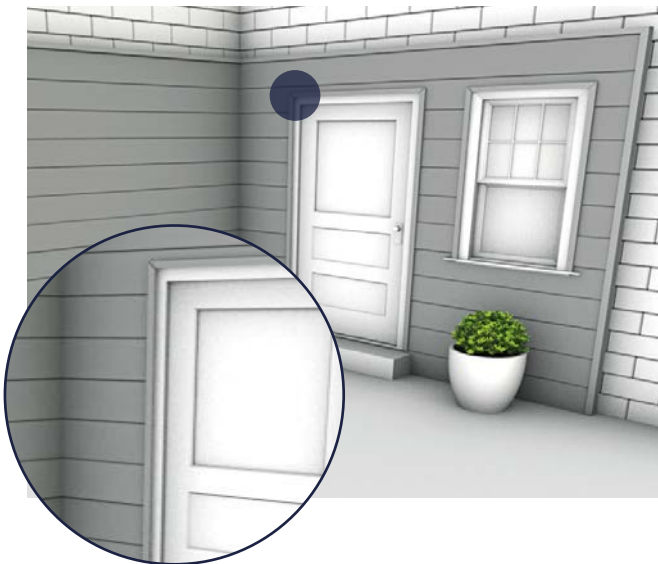

Installing the Corner Trims is the last phase of the project. Install the Composite Wall Cladding as above right up to any windows or doors.

Take the Corner Trim and measure the length of the area it's going to be fitted on, for example the width and height of a door or window. Corner Trims can be cut to length and worked just like timber. If placing two trims side by side, these can either be mitered to create a neat angle, or cut to fit.



Once the Corner Trim is cut to size, you can use Sumogrip adhesive along one or both sides of the Corner Trim to attach to the edge of the Cladding.

To allow for expansion you may wish to only glue the top edge. Once installed, you can then cut and place the second piece of trim along the edge until you have the desired finished look.



## INSTALLATION GUIDES

For full product Installation Guides, please see our website to download.



## GALLERY

Need some inspiration? Visit our Gallery on our website.



# FIBRE CEMENT WALL CLADDING Installation Guide



Pictured - Cream Fibre Cement Wall Cladding

## DO'S & DON'TS



Do not install Fibre Cement Wall Cladding if the Boards, building or the surrounding areas are wet.



Do not cut the Fibre Cement Wall Cladding Boards indoors.

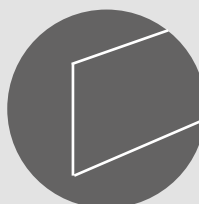

Always carry Fibre Cement Boards horizontally with the help of another physically able person.



Do not dry sweep dust or debris off the Boards, as it may cause the particles to enter the air and could be inhaled - wipe away with a damp cloth.



Always follow the manufacturer's safety recommendations when using saws or other machinery.



Nail guns can be used for fixing the Boards.

## TOOLS



### Protective Equipment

When handling or carrying Fibre Cement Wall Cladding Boards or Trims, it is advised to wear long sleeves and cut level 5 protective gloves to protect any exposed skin. When cutting Boards, to protect yourself from the dust a level P3 respiratory protective mask must be worn. Ear defenders and safety glasses are also recommended.



### Cutting Tools

A standard wet circular saw blade with carbide teeth, or a hand-held wet circular saw with a diamond saw blade, will be able to cut through the material, if necessary. Straight Cut Tin Snips, or a metal hacksaw, can be used to cut through the aluminium Trims and Perforated Closures.

# PREPARING THE WALL

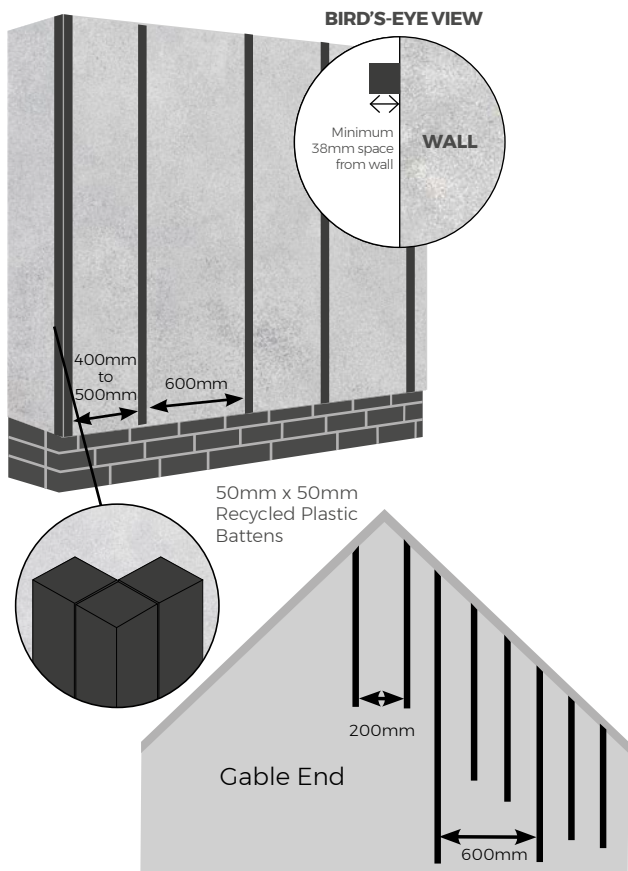

## STEP 1: BATTENS

**Install 50mm x 50mm Recycled Plastic Battens flush to the wall, creating a minimum 38mm ventilation gap between the wall and the Fibre Cement Cladding Boards.**

Battens must be no more than 600mm apart, reducing to 400mm or 500mm at boundary areas, and a clear space of 38mm should be left at the base of the Battens.

If your home has a gable end, Battens must be spaced up to 600mm apart with additional, shorter supporting Battens installed every 200mm between, going up and down the apex (the triangular shape of your gable end). This ensures the Boards are fully supported across the entire build.

Ensure all Battens are vertical and level using either a tape measure or a spirit level before moving on to the Trims and details.

**Please note:** the Damp Proof Course must be installed on any Battens around corners, or on any double Battens (where two Cladding Boards are butted together).

# INSTALLATION

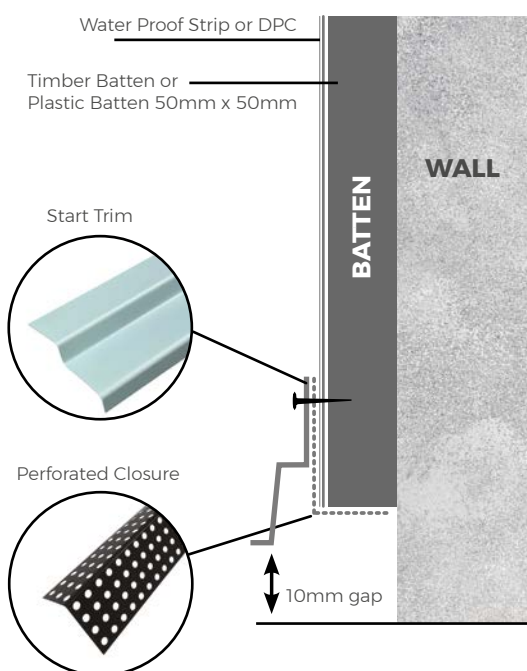

## STEP 2: CORNER TRIMS AND START TRIM

Once the Battens are installed a Water Proof Strip or DPC (Damp Proof Course) must be fitted to any Batten which will have a Corner Trim attached to it, or borders any windows or doors. Fix the DPC using a staple gun at regular intervals. Then, at the base of the Battens secure the Perforated Closure using 39mm Fibre Cement Screws.

Fix Corner Trims to the Battens, ensuring each Trim overlaps the Batten on either side by 10mm. Fix the Trim to the Batten using 39mm Fibre Cement Screws, at regular intervals until the Trim is secure.

Screw the Start Trim to the Batten, as per the diagram, only at the top of the Trim and through both the Batten and Perforated Closure at the base.

Ensure the lip of the Start Trim is just below the base of the Batten. Make sure there is a 10mm clearance between the base of the Trim and the base of the wall.

# FIBRE CEMENT WALL CLADDING INSTALLATION GUIDE

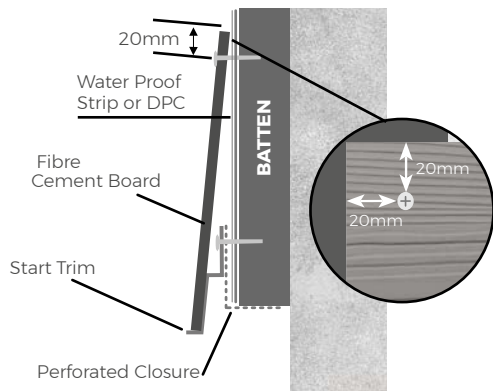

## STEP 3: FIXING THE FIRST BOARD

The first Board will be fixed to the side of the building using the attached Start Trim as a support.

Mark 180mm up from the base of the Start Trim and ensure it is level. This will be where the top of your first Board will sit.

Sit the Board securely onto the Start Trim and fix to the Battens behind with a 40mm Wood Screw. Screws should always be inserted at the top of the Board into the Battens.

There must be a 20mm clearance gap between the edge of the Board and each Screw.

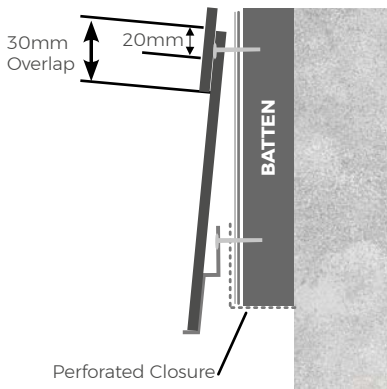

## STEP 4: FIXING THE REST OF THE BOARDS

Place your second Fibre Cement Wall Cladding Board so that the base of the Board overlaps the top of the first Board by a minimum of 30mm. The dimensions of the overlap must be maintained throughout the installation.

Insert 40mm Wood Screws through the top of the new Cladding Board into the Batten as before.

Once the Board has been secured, measure 180mm from the top of the Board to give the next Board's top edge height. This is to ensure that the correct gaps are being met throughout the installation. Install the rest of the Boards following this method.

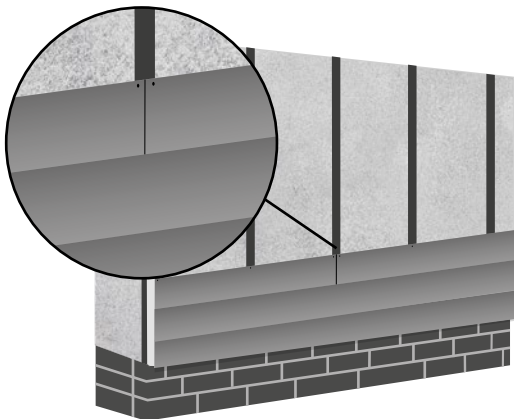

**TOP TIP** To ensure coverage of your desired width, the Fibre Cement Wall Cladding Boards may need to be butted together. The Boards can be flush next to each other, as the Boards have a minimal expansion and contraction. When two Boards meet, they must be supported by two adjacent Battens behind.

The double Battens must both be fitted with a Damp Proof Course before the Boards are installed.

## STEP 5: INSTALLING YOUR LAST BOARD

It is unlikely that Boards will fit exactly to your wall height, and so it may be necessary to cut the last Board to the correct width. To ensure the Board is cut correctly, measure the distance from the top of the previous Cladding Board to the top of your wall, ensuring to include the 30mm overlap.

Leave enough space for a 10mm ventilation gap between the Boards and the underside of the soffit. Once the last Board is cut to size, install exactly as before using 39mm Fibre Cement Screws with colour-matching heads.

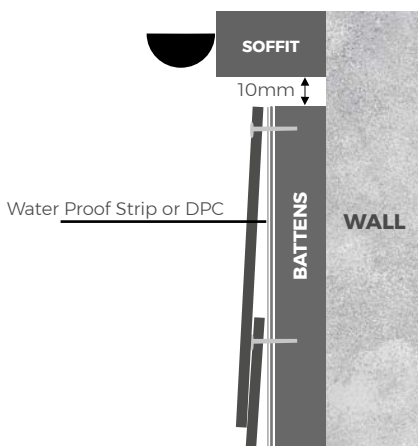

**TOP TIP** Check the installation with a spirit level every four rows to ensure the angle and level of each Board is maintained throughout.

# TRIMS INSTALLATION

**SINGLE & DOUBLE CONNECTION TRIMS**  
Installed to the inside edges of window reveals and door frames to support Boards.

**SYMMETRIC EXTERNAL CORNER TRIM**  
Designed to fit on the corners of the building, Fibre Cement Wall Cladding Boards are installed to the flat edges of the Trim.

**INTERNAL CORNER TRIM**  
Used in the internal corners of a building for a neat, seamless finish.

**WALL END TRIM**  
Installed on the finishing edge to conceal exposed ends of Fibre Cement Wall Cladding Boards.

**PERFORATED CLOSURE**  
Installed under the Battens at the base of the build, or at the top of any doors and windows, to ensure ventilation throughout the installation. Perforated Closure also protects the build from any dirt or insects penetrating the air flow space.

**START TRIM**  
Installed at the start of new Board runs at the base of the building.

**ASYMMETRIC EXTERNAL CORNER TRIM**  
Designed to be installed on either side of the door or window, allowing Boards to be fitted on the flat surface of the Trim.

**IF YOU REQUIRE ADDITIONAL TRIMS AND FIXINGS FOR YOUR PROJECT, PLEASE SPEAK TO US FOR ASSISTANCE.**

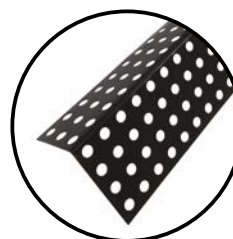
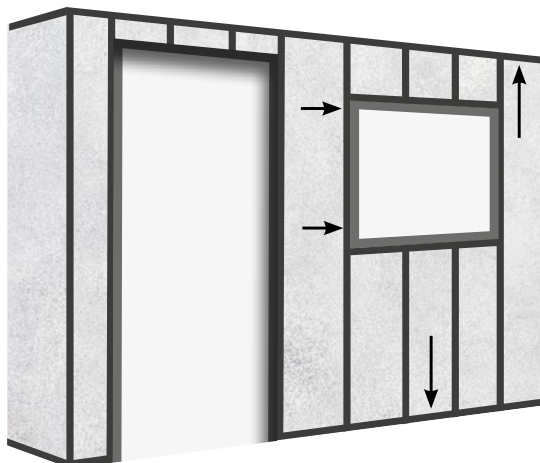

## STEP 1: INSTALL PERFORATED CLOSURES

Perforated Closure must be installed before the Trims. Start by

measuring the width of the top and bottom of the walls and windows, as well as the width of any doors. Cut the Perforated Closure to the correct lengths using Straight Cut Tin Snips. Using 39mm Screws, fix the Perforated Closure onto the Battens along the top and bottom of the walls, windows and the top edge of any door frames.

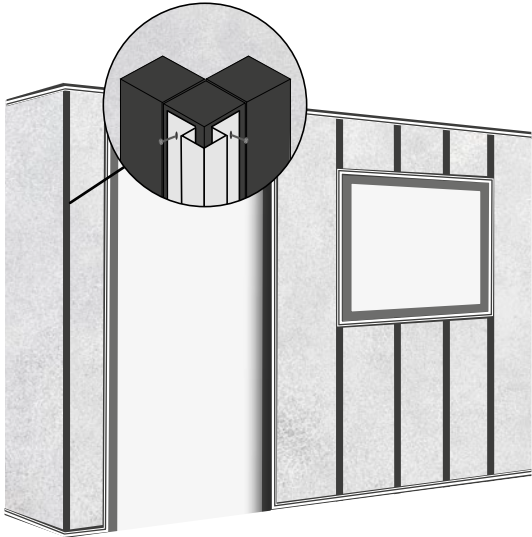

## STEP 2: MEASURE AND INSTALL CORNER TRIMS

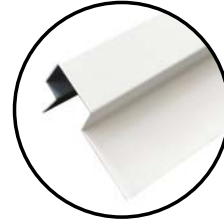

Measure the height of all external and internal corners of your building, as well as the height of windows and doors. Once measured, use Cladco Straight Cut Tin Snips to cut the Symmetric Corner Trims (for external wall corners), Asymmetric External Corner Trims (for external window and door corners), and Internal Corner Trims (for internal wall corners) to the correct sizes. Use 39mm Screws to install each of the Corner Trims into place.

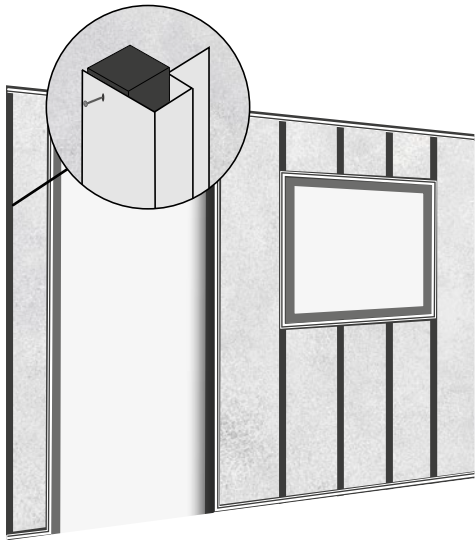

## STEP 3: MEASURE AND INSTALL WALL END TRIMS

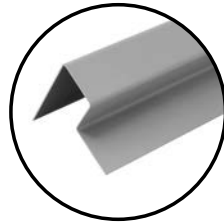

Measure the height of the Battens along the outer edge of your Fibre Cement Wall Cladding installation and cut the Wall End Trims to matching lengths. Fix the Wall End Trim on top of the Batten using 39mm Fibre Cement Screws with colour-matching heads before installing Boards.

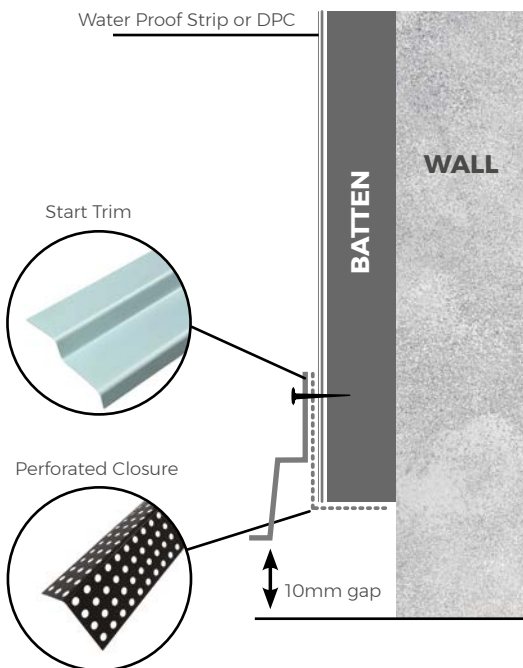

## STEP 4: INSTALL START TRIMS



Measure the length of the base of your wall and cut the Start Trim to the correct size using Cladco Straight Cut Tin Snips. Using 39mm Screws, secure the Start Trim over the top of the Perforated Closure and overlap the External and Internal Corners Trims installed in the previous steps. Leave at least a 10mm gap from the base of the wall to the Start Trim.

# WINDOWS AND DOORS

The Battens above the windows or doors will need to be installed as per Step One with the Perforated Closure cut to the same length as the top section of a window or door frame and installed underneath the Fibre Cement Cladding Boards. Before the Wall Cladding can

be installed around any windows or doors, Asymmetric External Corner Trims must be fixed to the Battens, fitted using 38mm Screws at regular intervals. If your doors, windows or walls require bespoke Trims, these are fitted here instead of the Asymmetric External Corner Trims.

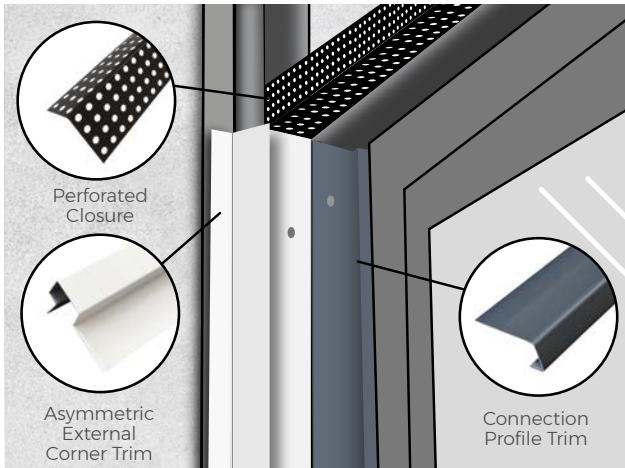

**STEP 1** Alongside the Asymmetric External Corner Trims previously installed around windows and doors, secure Connection Profile Trims to the internal corners of a window or door reveal using 39mm Screws, as shown in the diagram. Make sure that the small painted edge of the Connection Profile Trim sits neatly against the window or door frame.

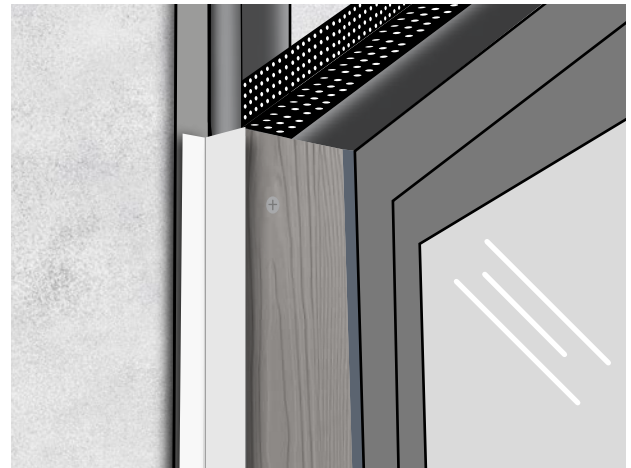

**STEP 2** Cladco Fibre Cement Boards can be cut to the same width as the window or door reveals using a wet saw and a Level P3 Respiratory Protective Mask. Slot the Board between the Connection Profile Trim and the Asymmetric External Corner Trim. Use 39mm Fibre Cement Screws with colour-matching heads to fix the Boards into place.

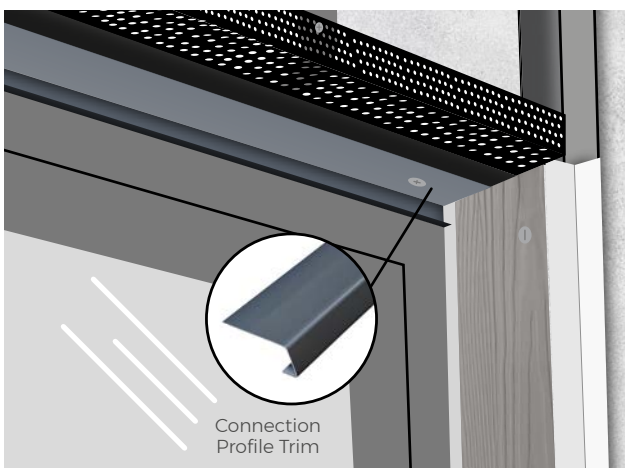

**STEP 3** Measure a Connection Profile Trim to fit the top internal corner of a window or door head. Cut the Connection Profile Trim using Cladco Straight Cut Tin Snips and secure into place using 39mm Screws. This will provide adequate support for the overhanging Fibre Cement Board under the window or door head.

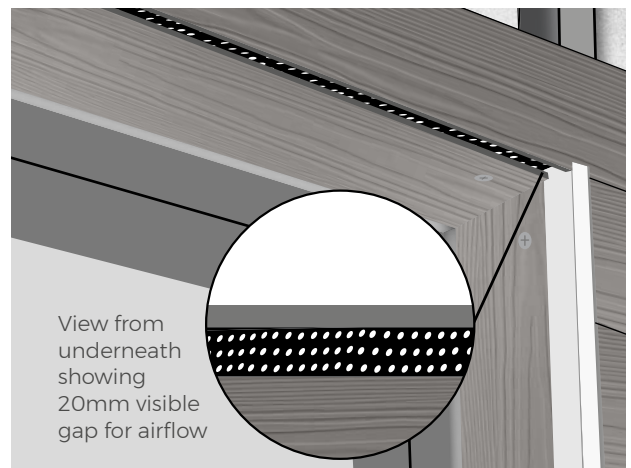

**STEP 4** Measure and cut the Fibre Cement Board in the same way as before and secure the Fibre Cement Board in place using 39mm Fibre Cement Screws with colour-matching heads. Make sure there is at least a 20mm gap between the edge of the Board and the Perforated Trim to allow for adequate airflow.

**STEP 5** Before installing the next Fibre Cement Board above a window or door frame, a section of the Board matching the width of the window or door frame will need to be measured and cut using a wet saw. Once cut, secure the Board in place using 39mm Screws into supporting Battens.



## Have you seen our Social Media Channels?

We are always looking for projects to share with our customers. If you would like to feature, please send your images to [images@cladco.co.uk](mailto:images@cladco.co.uk)

Pictured - Cedar Wood Nordeck Woodgrain Effect Decking Boards





CLADCO

DECKING

EXTERNAL CLADDING

INTERNAL PANELLING

FENCING

INSTALLATION GUIDES

CASE STUDIES

# Case Studies

Take a look at these recent projects to see how some of our customers have used Cladco products. Further Case Studies can be seen by visiting our website or social media channels.

# COMPOSITE DECKING & CLADDING | CHARCOAL

Winners of our Content Contest 2024, Rowe Architects chose our Composite Decking Boards and Woodgrain Effect Composite Cladding, both in Charcoal, to complete this incredible design studio. The dark tones of Charcoal Woodgrain Effect Composite Cladding and Decking create a vibrant contrast between the natural wood cladding and flora at the bottom of the garden.



Composite Decking Boards provide the perfect raised entrance into their studio, creating a relaxing seating area at the same time.



Our Woodgrain Effect Composite Cladding and Composite Decking Boards provide a low-maintenance exterior solution, divided by natural timber slats.

CLADCO

DECKING

EXTERNAL CLADDING

INTERNAL PANELLING

FENCING

INSTALLATION GUIDES

CASE STUDIES

Photographs courtesy of Rowe Architects

## NORDECK WOODGRAIN DECKING | CEDAR WOOD

This luxury holiday cottage by Oakwood West Holidays required a high-quality Decking space fit for purpose. Cladco Nordeck Woodgrain Effect Decking Boards offered all the qualities the company was looking for, including a realistic woodgrain effect surface and durability around an outdoor kitchen area.



Without any natural wood fibres, the durability of the tough ASA-resin shell, combined with water-resistant properties, made Nordeck Decking Boards perfect for installation around areas prone to standing water, such as hot tubs.

The embossed woodgrain effect surface of Cladco Nordeck Decking Boards complements the natural elements surrounding the cottage, helping to enhance the overall experience for holiday-goers and visitors.

The scratch-resistance surface of Nordeck Decking helps to keep marks and scratches at bay from pet claws. As a splinter-resistant material, Nordeck Decking is safer underfoot when compared to traditional timber.

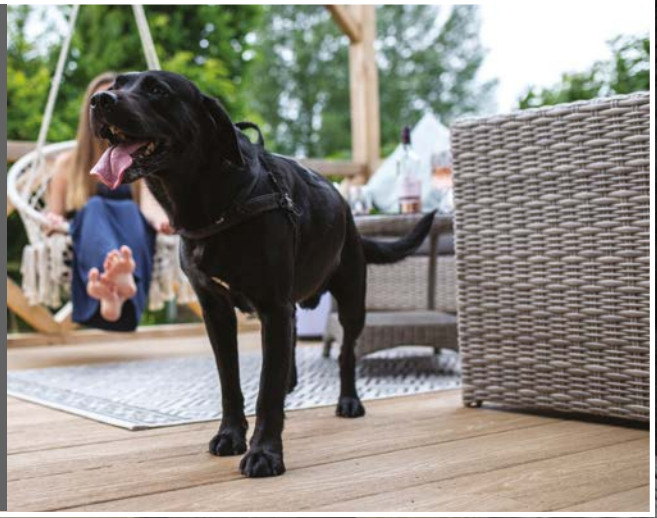

Nordeck Fascia Boards in matching Cedar Wood colour have been installed around the steps to create a professionally-finished edge. Adding to the design of the Decking space, matching Nordeck Bullnose Boards help to retain a high-quality finish after being carefully fitted around brickwork and other objects.

Cladco Nordeck Decking Boards are tough underfoot, which makes them perfect for heavy furniture, tables and chairs, as well as areas that experience high levels of footfall.



CLADCO

DECKING

EXTERNAL CLADDING

INTERNAL PANELLING

FENCING

INSTALLATION GUIDES

CASE STUDIES

# COMPOSITE DECKING | WOODGRAIN STONE GREY

This fantastic garden has been transformed into a contemporary, outdoor living space using Cladco Composite Woodgrain Decking Boards in Charcoal and Stone Grey. Giving a modern twist on the traditional timber decking aesthetic, this has created a perfect space for these customers to relax, socialise and entertain.

The use of the two contrasting colours helps organise the design and focus on key points within the installation. The Stone Grey picture frame has been used to highlight the edge of the Decking. The Stone Grey Boards have also been installed in an attractive arrow shape on the steps, signalling the incline or decline onto different areas of the Deck.

Cladco Composite Charcoal Woodgrain Decking Boards have been installed horizontally. Installing your Decking Boards horizontally creates the illusion of a larger Deck and draws your eye to the attractive picture frame edge and hot tub pergola area.

The dark Cladco Composite Decking Boards contrast perfectly with the attractive timber Cladding used on fences and buildings within the garden. Cladco Composite Woodgrain Charcoal Decking Boards have also been used to clad the exterior of the hot tub house. The continuity across multiple design aspects draws your attention to different parts of the garden.



SCAN ME

# COMPOSITE WALL CLADDING | IVORY

This traditional shepherd's hut has been transformed into a modern and comfortable holiday location for families and friends to enjoy in the great outdoors. Cladco Composite Wall Cladding Boards in Ivory were used elegantly to adorn the exterior walls, providing a low-maintenance and contemporary alternative to steel sheets or wooden timber boards.

Often clad in traditional timber or corrugated metal sheets, shepherd's huts were not known for their stylish, cosy interiors. However, when @the\_hut\_life got hold of their shepherd's hut, they quickly converted it into a glamorous yet rustic living space using Cladco Composite Wall Cladding to protect it from the elements.

What was once used for nursing injured lambs or sheep, this little home on wheels, featuring Composite Wall Cladding Boards, provides an alternative retreat.



Cladco Composite Cladding has been expertly measured and installed to fit around this hut's windows and doors, allowing for ample natural light to enter during the day.



SCAN ME

Have a project you would like to share?

We are always looking for projects to share with our customers. If you would like to feature, please send your images to [images@cladco.co.uk](mailto:images@cladco.co.uk)



Pictured - Pebble Grey Internal Slatted Wall Panels

Cladco Profiles is a family owned company offering quality products at competitive prices.

Established in 1972, we have steadily grown to become the leading provider of Composite Decking and outdoor materials to businesses and households throughout the UK.

#### Head Office

Cladco Profiles, Beardown Road, Exeter Road Industrial Estate, Okehampton, Devon EX20 1UA

**T:** 01837 659901

**E:** [info@cladco.co.uk](mailto:info@cladco.co.uk)

#### Andover Branch

Cladco Profiles Andover, 55 Reith Way, Andover, Hampshire SP10 3TY

**T:** 01264 598231

**E:** [info@cladco.co.uk](mailto:info@cladco.co.uk)

Brochure printed October 2024

[www.cladcodecking.co.uk](http://www.cladcodecking.co.uk)



All information is correct at time of print. All measurements given are approximate and due to the manufacturing process may vary slightly. Images are used for illustration purposes only, actual item may vary slightly from the image supplied.

**CLADCO**  
PROFILES

